



22" Full HD monitor with VA panel

The ProLite XU2294HSU featuring VA panel technology guarantees accurate and consistent colour reproduction with wide viewing angles. Triple input configuration (VGA, HDMI, DisplayPort) and a USB hub assure compatibility with many platforms. High contrast and brightness values mean the monitor will provide excellent performance for photographic and web design.



VA matrix

VA panel technology offers higher contrast, darker blacks and much better viewing angles than standard TN technology. The screen will look good no matter what angle you look at it.



Flicker-free + Blue light

The ultimate solution for the comfort and health of your eyes. Flicker-free monitors with the blue light reducer function substantially reduce the strain and fatigue caused by flickering and blue light emittance of regular monitors.

01 DISPLAY CHARACTERISTICS

Design	ultra slim
Diagonal	21.5", 54.6cm
Panel	VA, matte finish
Native resolution	1920 x 1080 @75Hz (HDMI&DisplayPort, 2.1 megapixel Full HD)
Aspect ratio	16:9
Brightness	250 cd/m ² typical
Static contrast	3000:1 typical
Advanced contrast	80M:1
Response time	4ms
Viewing zone	horizontal/vertical: 178°/178°, right/left: 89°/89°, up/down: 89°/89°
Colour support	16.7mIn 8bit (6bit + Hi-FRC) (sRGB: 99%; NTSC: 72%)
Horizontal Sync	30 - 85KHz
Vertical Sync	55 - 75Hz
Viewable area W x H	476 x 267.8mm, 18.7 x 10.5"
Pixel pitch	0.248mm
Colour	matte, black

02 INTERFACES / CONNECTORS / CONTROLS

Signal input	VGA x1 (1920 x 1080 @60Hz) HDMI x1 (1920 x 1080 @75Hz) DisplayPort x1 (1920 x 1080 @75Hz)
USB HUB	x2 (v.2.0)
HDCP	yes
Headphone connector	yes

03 FEATURES

Blue light reducer	yes
Flicker free	yes
OSD languages	EN, DE, FR, ES, IT, RU, JP, CZ, NL, PL
Control buttons	Power, Menu/ Select, Scroll up/ Volume, Scroll Down/ ECO, Exit, Input
User controls	auto adjust, picture adjust (brightness, contrast, ECO, Blue Light Reducer, ACR, OD), geometry (H. position, V. position, pixel clock, phase), colour settings (colour temp., user preset, i-Style colour), OSD (OSD H. position, OSD V. position, OSD rotate, OSD time), language, recall, miscellaneous (sharp and soft, video mode adjust, opening logo, display information), input select (input source), audio settings (volume, mute, audio input)
Speakers	2 x 1W
Convenience	Kensington-lock™ prepared, DDC2B, Mac OSX

04 MECHANICAL

Display position adjustments	tilt
Tilt angle	22° up; 5° down
VESA mounting	100 x 100mm
Operation temperature range	5°C - 35°C
Storage temperature range	- 20°C - 60°C

05 ACCESSORIES INCLUDED

Cables	power, USB, HDMI
Other	quick start guide, safety guide

06 POWER MANAGEMENT

Power supply unit	internal
Power supply	AC 100 - 240V, 50/60Hz
Power usage	19W typical, 0.5W stand by

07 SUSTAINABILITY

Regulations	CE, TÜV-GS, VCCI-B, PSE, CU
Energy efficiency class	A+
Other	REACH SVHC above 0.1%: Lead

08 DIMENSIONS / WEIGHT

Product dimensions W x H x D	488.5 x 376 x 187mm
Weight (without box)	3kg
EAN code	4948570117291

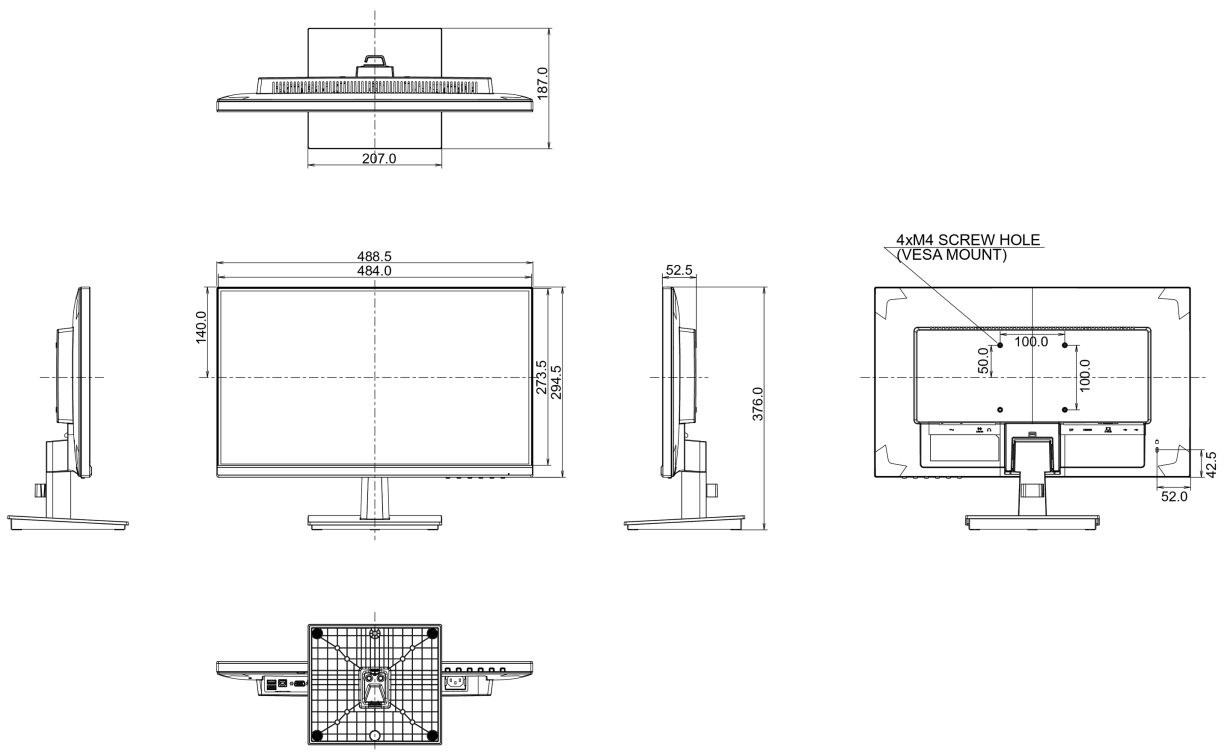

10 EU ENERGY EFFICIENCY LABEL

Manufacturer	iiyama
Model	ProLite XU2294HSU-B1

Energy efficiency class	A+
Visible screen diagonal	54.6cm; 21.5"; (22" segment)
ON mode power consumption	16W
Annual energy consumption	23kWh/annum*
Power in Standby	0.5W stand by
Power in OFF Mode	0.26W off mode
Resolution	1920 x 1080

*This is information under Regulation (EU) No 1062/2010.*Based on the power consumption of the television operating 4 hours per day for 365 days. The actual energy consumption will depend on how the television is used.*

All trademarks and registered trademarks acknowledged. E & O E. Specification subject to change without notice. All LCD's comply with ISO-9241-307:2008 in connection with pixel defects.

© IIYAMA CORPORATION. ALL RIGHTS RESERVED