

Unpacking the Leitz Icon Printer

Check that the items below are included in your printer package. If any of these items are missing or damaged, visit www.leitz.com/icon to contact Customer Support.

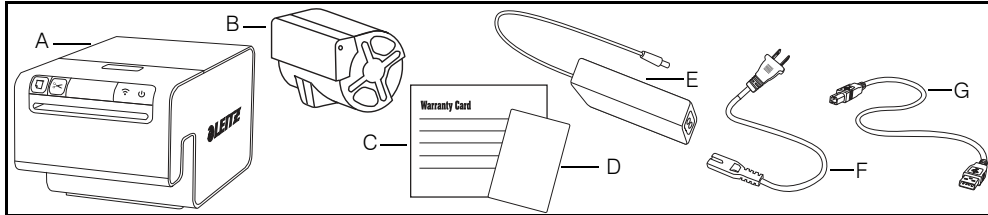

A Leitz Icon printer	D Cleaning card	G USB cable
B Starter label cartridge	E Power adapter	
C Warranty leaflet	F Power cord	

Getting to Know the Printer

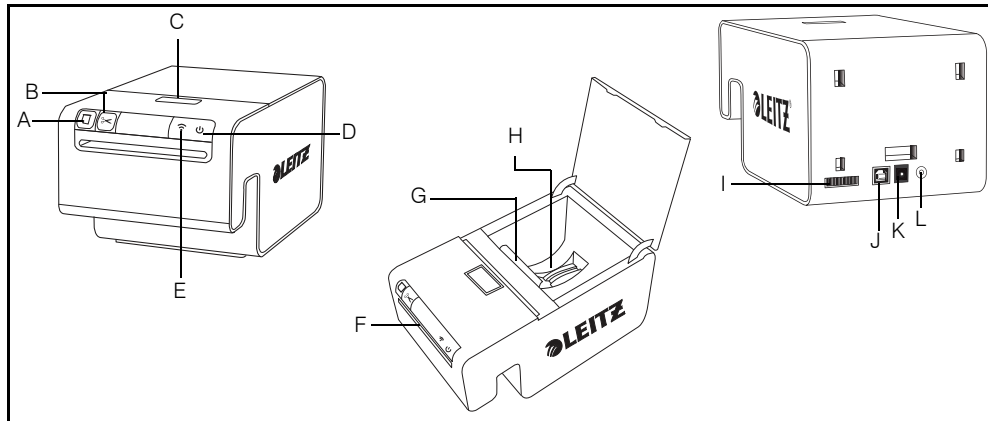

A Feed button	E Wireless status light	I Battery connector
B Cutter button	F Label exit slot	J USB connector
C Cartridge door button	G Label guide latch/platen release	K Power connector
D Power status light	H Label compartment	L Wi-Fi Protected Setup (WPS) button

Installing the Software

Software installation must be complete before connecting the printer to your computer.

Installing the Software

1. Download the latest version of the Leitz Icon Software from the Leitz website at www.leitz.com/icon.
2. Open the **Downloads** folder on your computer and double-click the Leitz Icon Software installer file.
3. In the dialog box that appears, double-click  to start the installer.
4. Follow the on-screen instructions to install the software.

Connecting the Power

The printer is powered using the included AC power adapter and power cord.

1. Plug the power cord into the power adapter.
2. Plug the power adapter into the power connector on the back of the printer.
3. Plug the power cord into an available power outlet.

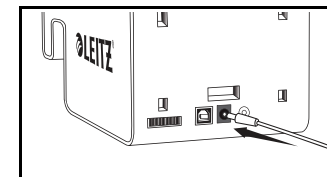
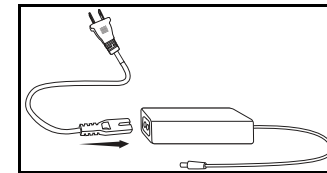

An optional, external, rechargeable battery is available for using the printer as a portable device. Refer to the *Leitz Icon Printer User Guide* (available at www.leitz.com/icon) for information on using the optional battery.

Connecting the Printer to Your Computer

You can connect your printer to your computer wirelessly or using the included USB cable. See the following sections for details:

- **Setting Up the Printer Using USB**
- **Setting Up the Printer for Wireless Use**

Setting Up the Printer Using USB

After downloading and installing the software, connect the power to the printer (see **Connecting the Power**) and attach the USB cable to your computer.

NOTE Software installation must be complete before connecting the printer to your computer.

1. Plug the USB cable into the USB connector located on the back of the printer.
2. Plug the other end of the USB cable into an available USB port on your computer.

The necessary driver to print to your printer is installed. Once the installation is complete, you will be able to print your first label.

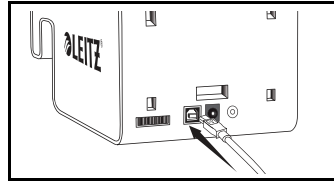

Next, see **Getting to Know the Label Cartridge** to learn more about the Leitz Icon Intelligent Label Cartridges.

Setting Up the Printer for Wireless Use

In order to use your printer via a wireless connection, the following two discrete steps are required:

1. Connect the printer to your network.
2. Add the printer to your computer and install the printer driver.

On initial setup, and later, in the absence of a recognized network, your printer will switch to what is known as "Soft AP" mode, where the printer creates its own Wi-Fi network for wireless printing. When connecting your printer to an existing network, you will use Soft AP mode to connect to the printer and select the home or office network to which you want the printer to be attached. Later, if you move the printer to another location where the network is not available, the printer will switch back to Soft AP mode so you can connect to it and print using its own broadcast network.

Connecting the Printer to Your Network

1. On your computer, search for available wireless networks.
For information on searching for wireless networks, see the documentation for your computer.
2. From the list of available networks, select your Printer ID.

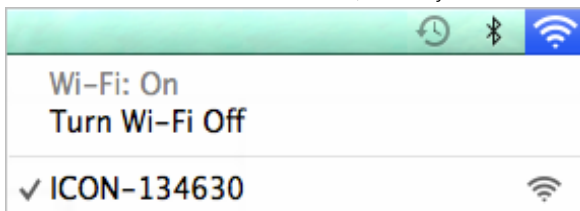

The Printer ID is formatted as **ICON-xyyzz** and can be found on the label on the bottom of your printer.

NOTE If the label on the bottom of your printer does not contain the Printer ID, you can determine the Printer ID using the printer's MAC address. In this case, the Printer ID is formatted as **ICON-xyyzz**, where xyyzz is the last six characters of your printer's MAC address (found on the label on the bottom of your printer). For example, if your printer's MAC address is **MAC:00:1E:CO:13:13:A5**, the Printer ID is **ICON-1313A5**.

3. Once connected, start a web browser on your computer.
4. In the address bar, type **192.168.1.1** and then press **Enter**.
5. Enter your user name and password in the **User name** and **Password** boxes.

The default user name and password are as follows.

User name: admin

Password: password

You can change this user name and password at any time; see the **Leitz Icon Printer User Guide** for more information.

6. Click **OK**.

The Leitz Icon Control Panel is displayed.

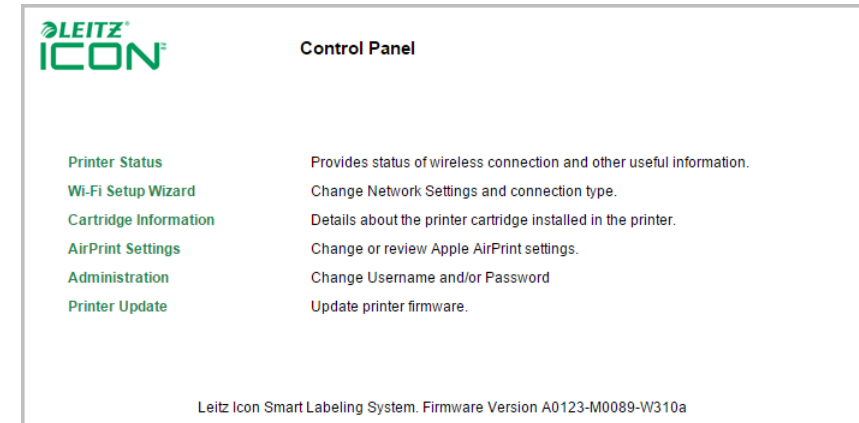

7. Click **Wi-Fi Setup Wizard**.
8. Click **Connect to Existing Network**.
The Select Your Wireless Network page is displayed.
9. Select your wireless network in the **Available Networks** list.
10. If prompted, enter your network password and then click **OK**.
11. Click **Next**.

The Connection Settings page is displayed with the most common, default setting selected.

12. Unless you are performing an advanced installation needing a specific static IP address, click **Next** to use the default settings.

13. On the **Confirm & Connect** page, click **Connect**.

As the printer connects to the selected network, you may hear a noise as the printer resets. At the same time, the wireless connection from your computer to the printer is dropped and you will need to reconnect your computer to your wireless network.

14. Close the Leitz Icon Control Panel.

Adding the Printer to Your Computer

This section describes how to add the printer and install the printer driver.

1. Start **System Preferences**, and then click **Printers & Scanners**.
2. Under the **Printers** list, click **+** and then click **Add Printer or Scanner**.

The Add dialog box appears.

3. Click **Leitz Icon** in the list of available devices.

The **Kind** column should display **Bonjour**.

4. In the **Use** list, do one of the following:

- Select **Leitz Icon**.

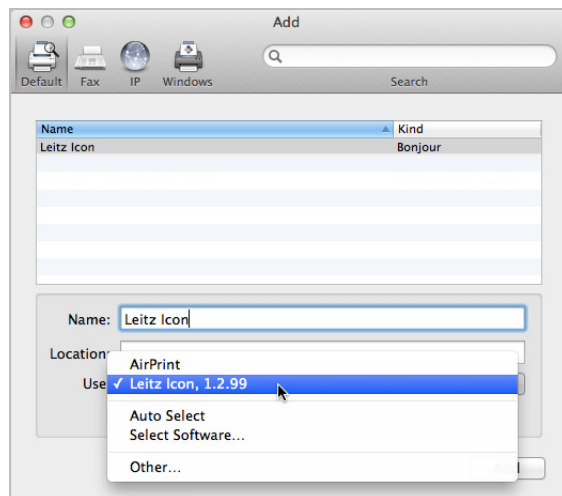

NOTE If more than one Leitz Icon version appears in the list, select the most recent version.

- If **Leitz Icon** does not appear in the list, do the following:
 - a. Click **Select Software**.
 - b. In the **Printer Software** dialog box, click **Leitz Icon**.
 - c. Click **OK**.
- 5. **(Optional)** In the **Name** box, type a useful, recognisable name for the printer such as **Matt's Leitz Icon**.
- 6. **(Optional)** In the **Location** box, type the location of the printer.
- 7. Click **Add**.

The printer is added to the Printers list and is now available for printing.

Getting to Know the Label Cartridge

Leitz Icon Intelligent Label Cartridges are easy to load into the printer and are recyclable*. Each cartridge has a folding label guide that opens to load and print labels and closes to protect labels during storage. The Intelligent Label Cartridge uses a special cartridge identification chip to relay information about the label cartridge, such as the type and size of the labels, the capacity of the label cartridge, and the number of labels remaining, to the software.

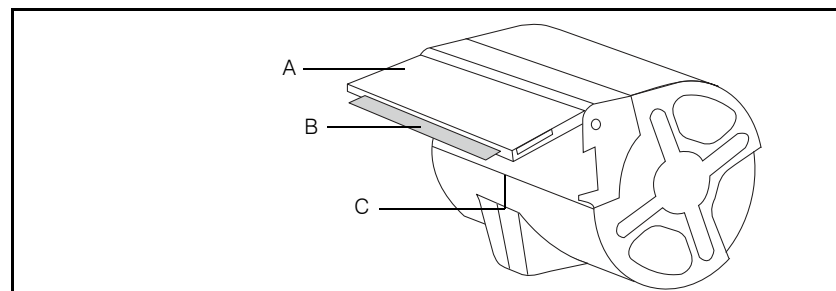

A Folding label guide **B** Label exit slot **C** Cartridge identification chip

NOTE Avoid handling the cartridge identification chip as this may damage the chip. If the chip becomes damaged, the label cartridge may not work properly.

*Intelligent Label Cartridges may not be recyclable in your area.

Loading Labels

1. Push the button on the top of the printer to open the cartridge door.

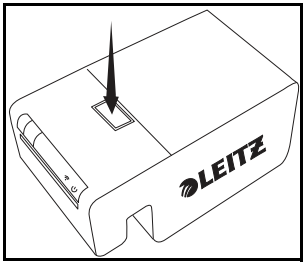

2. Lift the label guide latch as shown.

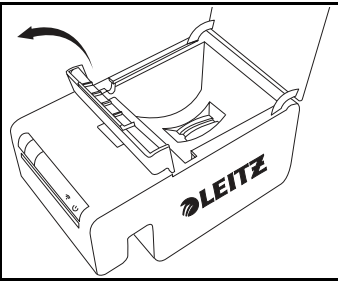

3. Pull open the folding label guide on the label cartridge until it locks into place.

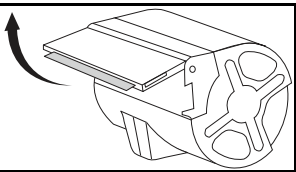

NOTE Avoid handling the cartridge identification chip as this may damage the chip. If the chip becomes damaged, the label cartridge may not work properly.

4. Place the cartridge into the printer as shown. Make sure the cartridge is centered and seated securely in the printer.

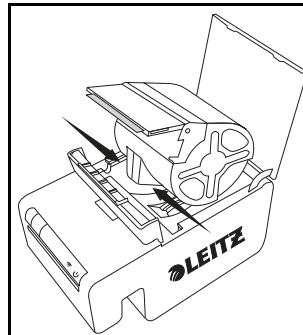

5. Lower the label guide latch.

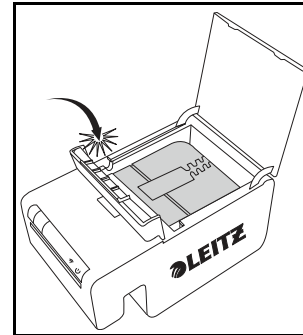

6. Close the cartridge door.

The printer automatically feeds the labels to the starting position.

Getting to Know Leitz Icon Software

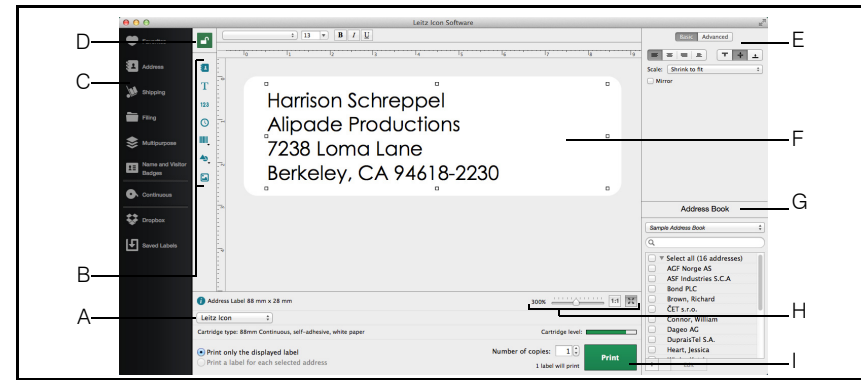

A	Select a printer	D	Lock/unlock label design	G	Create a custom Address Book or use your Mac Contacts
B	Add addresses, text, counters, the date and time, barcodes, shapes, or images	E	Format objects and customize object properties	H	Zoom the displayed label
C	Select the label category, type, and template	F	Edit the label	I	Print a label

For details on all of the Leitz Icon Software features, click **Help**.

Printing Labels

Using the Leitz Icon printer, you can print a wide variety of adhesive labels as well as non-adhesive name badges, notes, and appointment cards.

This section describes how to print a basic Address label. For detailed information about printing other types of labels, refer to the **Leitz Icon Software Help** (available from the **Help** menu).

1. Click  to start Leitz Icon Software.
2. Click **Address** on the label selection pane.
The label selection pane expands to display the available types of Address labels.
3. Click **Address Label**.
The label selection pane expands to display the available Address label templates.
4. Click **Address Label**.
The label selection pane collapses and an Address label is displayed.
5. Click once on the displayed label to edit the text.
6. Type an address or other text on the label.
7. If desired, use the formatting pane to change the text formatting.
8. Click **Print** to print the label.

Additional Information

Visit the Leitz website at www.leitz.com/icon for additional information, including the latest software, firmware, user guides, news, and FAQs.

Copyright

© 2014 Esselte IPR AB. All rights reserved.
Leitz, Leitz Icon, Smart Labeling System, Intelligent Label Cartridge are trademarks of Esselte IPR AB or its affiliates.
Mac and iPad are trademarks of Apple Inc., registered in the U.S. and other countries.
iOS is a trademark or registered trademark of Cisco in the U.S. and other countries and is used under license to Apple.
The DYMO and DYMO Label trademarks are registered trademarks of Sanford, LP. Esselte is not affiliated with, endorsed, or sponsored by Sanford, LP.

Revised 10/2014