



**Intermec**



**User's Manual**



**CV60 Vehicle Mount  
Computer With  
Windows CE**

The Intermec logo features the word "Intermec" in a bold, italicized sans-serif font. To the left of the text is a stylized graphic element consisting of a vertical line that curves into a horizontal line, resembling a checkmark or a stylized 'I'.

**Intermec**



User's Manual

**CV60 Vehicle Mount  
Computer With  
Windows CE**

Intermec Technologies Corporation

Worldwide Headquarters  
6001 36th Ave.W.  
Everett, WA 98203  
U.S.A.

[www.intermec.com](http://www.intermec.com)

The information contained herein is provided solely for the purpose of allowing customers to operate and service Intermec-manufactured equipment and is not to be released, reproduced, or used for any other purpose without written permission of Intermec Technologies Corporation.

Information and specifications contained in this document are subject to change without prior noticed and do not represent a commitment on the part of Intermec Technologies Corporation.

© 2007 by Intermec Technologies Corporation. All rights reserved.

The word Intermec, the Intermec logo, Norand, ArciTech, Beverage Routebook, CrossBar, dcBrowser, Duratherm, EasyADC, EasyCoder, EasySet, Fingerprint, INCA (under license), i-gistics, Intellitag, Intellitag Gen2, JANUS, LabelShop, MobileLAN, Picolink, Ready-to-Work, RoutePower, Sabre, ScanPlus, ShopScan, Smart Mobile Computing, SmartSystems, TE 2000, Trakker Antares, and Vista Powered are either trademarks or registered trademarks of Intermec Technologies Corporation.

There are U.S. and foreign patents as well as U.S. and foreign patents pending.

Wi-Fi is a registered certification mark of the Wi-Fi Alliance.

Microsoft, Windows, and the Windows logo are registered trademarks of Microsoft Corporation in the United States and/or other countries.

Bluetooth is a trademark of Bluetooth SIG, Inc., U.S.A.

This product includes software developed by the OpenSSL Project for use in the OpenSSL Toolkit ([www.openssl.org](http://www.openssl.org)).

This product includes cryptographic software written by Eric Young ([EAY@cryptsoft.com](mailto:EAY@cryptsoft.com)).

This product uses Regex++, Index software during its operational phases. The owner of Regex++ has granted use of the software to anyone provided such use is accompanied by the following copyright and permission notice:

Regex++, Index. (Version 3.31, 16th Dec 2001)

Copyright © 1998-2001 Dr John Maddock

Permission to use, copy, modify, distribute and sell this software and its documentation for any purpose is hereby granted without fee, provided that the above copyright notice appear in all copies and that both that copyright notice and this permission notice appear in supporting documentation. Dr John Maddock makes no representations about the suitability of this software for any purpose. It is provided "as is" without express or implied warranty.

## Document Change Record

This page records changes to this document. The document was originally released as Revision 001.

<b>Version Number</b>	<b>Date</b>	<b>Description of Change</b>
003	03/07	Revised Chapter 3 to add information on how to use the CV60 association label to communicate with wireless scanners.
004	07/07	Revised to support 802.11 a/b/g radio functionality. Updates to this document included: <ul style="list-style-type: none"><li>• Adding a section in Chapter 3 on how to change 802.11 radio bands.</li><li>• Removed sections on configuring the BIOS and editing registry settings.</li><li>• Added new graphics to Chapter 1, “Using the CV60 Vehicle Mount Computer.</li><li>• Removed information on the Odyssey Client Manager support for Windows CE, since it only supports Windows XP/XPE.</li></ul>
005	09/09	Separate manuals were created for Windows CE and XP/XPE.



# Contents

Before You Begin . . . . .	viii
Safety Information . . . . .	viii
Global Services and Support . . . . .	viii
Warranty Information . . . . .	viii
Web Support . . . . .	viii
Telephone Support . . . . .	ix
Who Should Read This Manual . . . . .	ix
Related Documents . . . . .	x
Patent Information . . . . .	x

## 1 Using the CV60 Vehicle Mount Computer . . . . . 1

Introducing the CV60 Vehicle Mount Computer . . . . .	2
Understanding the Features of CV60 . . . . .	2
Using the Touch Screen . . . . .	4
Navigating and Using the Touch Screen . . . . .	5
Adjusting the Volume . . . . .	6
Adjusting the Screen Brightness . . . . .	6
Mounting the CV60 . . . . .	7
Connecting the CV60 to Power . . . . .	7
Understanding the Status Lights . . . . .	8
Installing an External Antenna . . . . .	10
Attaching an External Keyboard . . . . .	11
Connecting a Tethered Scanner . . . . .	11

## 2 Understanding Windows CE . . . . . 15

Understanding Windows CE . . . . .	16
Finding Information in Windows CE . . . . .	16
Learning the Basic Skills . . . . .	16
Using the Desktop Screen . . . . .	16
Accessing Programs . . . . .	17
Using the Taskbar . . . . .	17
Using Pop-Up Menus . . . . .	17
Entering Information . . . . .	17

## Contents

Finding and Organizing Information . . . . .	18
To open Windows Explorer . . . . .	18
Customizing the CV60 . . . . .	19
Using Microsoft ActiveSync . . . . .	19
Using Internet Explorer . . . . .	20
<b>3 Configuring the CV60 . . . . .</b>	<b>21</b>
Configuring CV60 Parameters . . . . .	22
Configuring the CV60 Using Intermec Settings . . . . .	22
Remotely Configuring the CV60 Using SmartSystems Foundation . . . . .	23
Setting Up Serial Communications . . . . .	23
Setting Up Ethernet Communications . . . . .	23
Setting Up Bluetooth Communications . . . . .	24
Configuring the CV60 to Communicate With a Wireless Scanner . . . . .	26
Configuring for Wireless Printing in Windows . . . . .	28
Using the Wireless Printing Applet to Select a Printer . . . . .	28
Selecting the Current Wireless Printer on the CV60 . . . . .	29
Setting Up 802.11 Radio Communications . . . . .	30
Configuring the Network Parameters for a TCP/IP Network . . . . .	30
Configuring the Network Parameters for a UDP Plus Network . . . . .	31
Configuring Security on the CV60 . . . . .	32
Understanding the Wireless Network . . . . .	32
Using WPA Security . . . . .	33
Using 802.1x Security . . . . .	34
Using LEAP Security . . . . .	34
Using Static WEP Security . . . . .	35
Choosing Between Funk and Microsoft Security . . . . .	35
Configuring Funk Security Using Intermec Settings . . . . .	35
Configuring Funk Security Using the Profile Wizard . . . . .	41
Configuring EAP-FAST with Profile Wizard . . . . .	50
Configuring Microsoft Security . . . . .	51
Loading a Certificate . . . . .	54
Disabling Security . . . . .	57
<b>4 Developing and Installing Applications . . . . .</b>	<b>59</b>

Developing Applications for the CV60 . . . . . 60  
    Developing a New Application . . . . . 60  
    Developing a Web-Based Application . . . . . 61  
    Converting a Trakker Antares Application for the CV60 . . . . . 61

Installing Applications on the CV60 . . . . . 61  
    Installing Applications Using SmartSystems Server . . . . . 62  
    Installing Applications Using Microsoft ActiveSync . . . . . 62  
    Installing Applications Using Wavelink Avalanche . . . . . 63

**5 Upgrading, Troubleshooting, and Cleaning the CV60 . . 65**

Upgrading the CV60 . . . . . 66  
    Increasing Hard Drive Space . . . . . 66  
    Increasing Memory . . . . . 68

Troubleshooting the CV60 . . . . . 69

Calling Product Support . . . . . 74

Cleaning the CV60 Screen . . . . . 75

**A Specifications . . . . . 77**

Specifications . . . . . 78

Accessories for the CV60 . . . . . 79

**Index . . . . . 81**



## Before You Begin

This section provides you with safety information, technical support information, and sources for additional product information.

### Safety Information

Your safety is extremely important. Read and follow all warnings and cautions in this document before handling and operating Intermec equipment. You can be seriously injured, and equipment and data can be damaged if you do not follow the safety warnings and cautions.

This section explains how to identify and understand cautions and notes that are in this document.



**A caution alerts you to an operating procedure, practice, condition, or statement that must be strictly observed to prevent equipment damage or destruction, or corruption or loss of data.**



**Note:** Notes either provide extra information about a topic or contain special instructions for handling a particular condition or set of circumstances.

### Global Services and Support

#### Warranty Information

To understand the warranty for your Intermec product, visit the Intermec web site at [www.intermec.com](http://www.intermec.com) and click **Service & Support > Warranty**.

#### Web Support

Visit the Intermec web site at [www.intermec.com](http://www.intermec.com) to download our current manuals (in PDF). To order printed versions of the Intermec manuals, contact your local Intermec representative or distributor.

Visit the Intermec technical knowledge base (Knowledge Central) at [intermec.custhelp.com](http://intermec.custhelp.com) to review technical information or to request technical support for your Intermec product.

**Telephone Support**

These services are available from Intermec.

<b>Services</b>	<b>Description</b>	<b>In the USA and Canada call 1-800-755-5505 and choose this option</b>
Order Intermec products	<ul style="list-style-type: none"> <li>Place an order.</li> <li>Ask about an existing order.</li> </ul>	1 and then choose 2
Order Intermec media	Order printer labels and ribbons.	1 and then choose 1
Order spare parts	Order spare parts.	1 or 2 and then choose 4
Technical Support	Talk to technical support about your Intermec product.	2 and then choose 2
Service	<ul style="list-style-type: none"> <li>Get a return authorization number for authorized service center repair.</li> <li>Request an on-site repair technician.</li> </ul>	2 and then choose 1
Service contracts	<ul style="list-style-type: none"> <li>Ask about an existing contract.</li> <li>Renew a contract.</li> <li>Inquire about repair billing or other service invoicing questions.</li> </ul>	1 or 2 and then choose 3

Outside the U.S.A. and Canada, contact your local Intermec representative. To search for your local representative, from the Intermec web site, click **Contact**.

**Who Should Read This Manual**

This manual is for the person who is responsible for installing, configuring, and maintaining the CV60.

This manual provides you with information about the features of the CV60, and how to install, configure, operate, maintain, and troubleshoot it.

## **Before You Begin**

Before you work with the CV60, you should be familiar with your network and general networking terms, such as IP address.

## **Related Documents**

The Intermec web site at [www.intermec.com](http://www.intermec.com) contains our documents (as PDF files) that you can download for free.

### **To download documents**

- 1 Visit the Intermec web site at [www.intermec.com](http://www.intermec.com).
- 2 Click **Service & Support > Manuals**.
- 3 In the **Select a Product** field, choose the product whose documentation you want to download.

To order printed versions of the Intermec manuals, contact your local Intermec representative or distributor.

## **Patent Information**

Product is covered by one or more of the following patents:

4912309; 4940974; 5216233; 5289378; 5345146; 5349678;  
5401591; 5404493; 5416463; 5440315; 5457629; 5465207;  
5473242; 5487161; 5500516; 5534684; 5536124; 5554822;  
5568645; 5576981; 5592512; 5598082; 5625555; 5671436;  
5694318; 5726937; 5736725; 5747748; 5796359; 5805474;  
5818027; 5873070; 5878395; 5889818; 5892971; 5895431;  
5896214; 5914481; 5928292; 5962837; 5987499; 5996080;  
6003773; 6026027; 6042414; 6049813; 6058000; 6061155;  
6112206; 6113047; 6124800; 6135810; 6149063; 6163359;  
6164545; 6174180; 6204825; 6212401; 6213400; 6229408;  
6234393; 6259044; 6292437; 6295461; 6356949; 6398105;  
6424542; 6488209; 6539064; 6694359; 6701361; 6731713;  
6857013; 6897776; 6944446; 6967280; 6970459; 6976062;  
7027037; 7034659

There may be other U.S. and foreign patents pending.



# **1 Using the CV60 Vehicle Mount Computer**

Use this chapter to familiarize yourself with the CV60 Vehicle Mount Computer. In this chapter, you will find these sections:

- Introducing the CV60 Vehicle Mount Computer
- Connecting the CV60 to Power
- Understanding the Status Lights
- Installing an External Antenna
- Installing an External Keyboard
- Connecting a Tethered Scanner

## Introducing the CV60 Vehicle Mount Computer

The CV60 is a rugged Vehicle Mount computer designed for real-time data collection applications in warehousing, distribution, work-in-process, time and attendance, and stationary applications. The CV60 is highly configurable and can be used with either Microsoft Windows CE.NET or Microsoft Windows XP/XPE operating systems. The CV60 supports the use of terminal emulation applications, browser-based applications, or custom applications. This manual covers the Windows CE based operating system for the CV60.

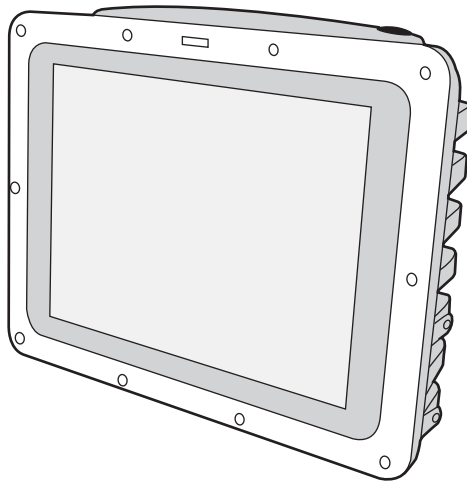

**CV60 Vehicle Mount Computer**



CV60 vehicle mount computers comes with an optional IEEE 802.11 b/g or a/b/g radio installed are Wi-Fi<sup>®</sup> certified for interoperability with other 802.11 b/g or a/b/g wireless LAN devices.

### Understanding the Features of CV60

The CV60 includes these standard features:

- 12.1" color SVGA display with optional heated display, and optional sunlight readable display
- Two USB ports, two COM ports, an Ethernet port, a headphone jack, and a microphone jack

## Chapter 1 — Using the CV60 Vehicle Mount Computer

- Optional 802.11 b/g or a/b/g radio
- Bluetooth radio
- 256 MB SDRAM with 512KB flash memory
- Intel® P-III Ultra Low Power 800MHz embedded processor

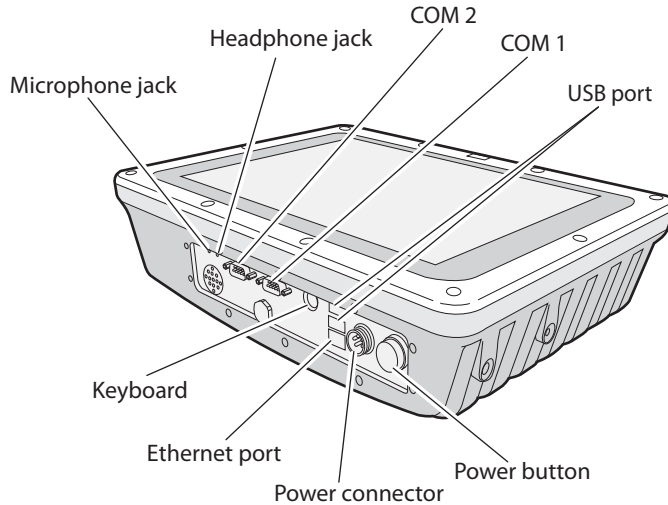

### ***Understanding the Ports and Buttons on the CV60.***

#### ***CV60 Port and Button Descriptions***

<b>Port and Buttons</b>	<b>Description</b>
Microphone jack	Connects a microphone to the CV60.
Headphone jack	Connects headphones to the CV60.
COM2	Connects the CV60 to other RS-232 devices such as PCs or printers.
COM1	Connects the CV60 to other RS-232 devices such as PCs or printers.
USB ports	Connects USB devices to the CV60.
Keyboard	Connects a PS/2 type keyboard to the CV60.

**CV60 Port and Button Descriptions**

<b>Port and Buttons</b>	<b>Description</b>
Ethernet port	Connects the CV60 to 10BaseT/100BaseT full duplex standard Ethernet interfaces.
Power connector	Connects the CV60 to an AC or DC/DC power supply.
Power button	Turns the CV60 on or off.

Use this manual to understand how to use the features and options available on the CV60. For a complete list of accessories available on the CV60, see [“Accessories for the CV60” on page 79](#).

**Using the Touch Screen**

The CV60 has a 12.1 inch color SVGA touch screen display. The touch screen has an optional heater to reduce condensation on the external surface of the display when moving between sub-freezing temperatures and normal temperatures.

If you are going to use the CV60 in extreme conditions (-30° to 50° C or -22° to 122° F) for an extended period of time, you should turn on the power at room temperature for at least 15 minutes prior to using it. This process of “warming up” the CV60 helps preserve the lighting on the display.

The default screen that appears on the display when you turn on the CV60 is the Windows CE Start screen. This screen appears unless you have the TE 2000 application installed on the CV60. If you have the TE 2000 application installed, it launches after the initial boot sequence.

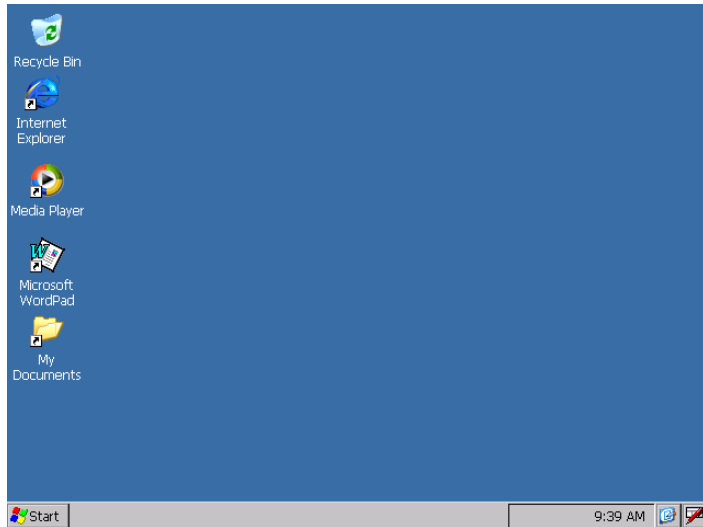

**CV60 with Windows CE Start Screen**

### **Navigating and Using the Touch Screen**

You can use the stylus accessory to navigate the touch screen. The next table describes how to use the touch screen on the CV60.

#### **Touch Screen Navigation**

<b>Action</b>	<b>Description</b>
Tap	Touch the screen once with the stylus or finger to select options, open or close applications, or launch menus.
Double-tap	Double-tap the screen with the stylus or finger to launch applications.
Drag	Hold the stylus or your finger on the screen and drag across the screen to select text, icons, and images.
Tap and hold	Tap and hold the stylus or your fingers on an item to see a menu of actions available for that item. On the pop-up menu that appears, tap the action you want to perform.



## Adjusting the Volume

You can change the CV60 volume, for sounds you hear when you tap the screen or scan bar codes with a scanner, to adjust your needs and the environment. You can set the volume to off, low, medium, high, and very high. Use the following table to understand the different ways to adjust the volume. Use the following table to understand the different ways to adjust the volume.

### Changing the Beeper Volume

Ways to Adjust Volume	Description
Use the Control Panel	From the <b>Start menu</b> , choose, <b>Settings</b> , select the <b>Control Panel</b> , and then double-tap <b>Volume &amp; Sounds</b> .
Using Intermec Settings	From the <b>Start menu</b> , choose, <b>Settings</b> , select the <b>Control Panel</b> , and then double-tap <b>Intermec Settings</b> . Go to <b>Device Settings &gt; Beeper &gt; Volume</b> .

## Adjusting the Screen Brightness

You may want to adjust the brightness of the screen depending on the location of the CV60.

### Changing the Screen Brightness

Ways to Adjust Volume	Description
Use the Control Panel	From the <b>Start menu</b> , choose, <b>Settings</b> , select the <b>Control Panel</b> , and then tap the <b>Display</b> tab. Use the slider to adjust the brightness of the screen.
Using Intermec Settings	From the <b>Start menu</b> , choose, <b>Settings</b> , select the <b>Control Panel</b> , and then double-tap <b>Intermec Settings</b> . Go to <b>Device Settings &gt; Backlight</b> .

## Mounting the CV60

To properly mount the CV60 to a desktop or vehicle, you must order a RAM Mount kit.



**Note:** Intermec rugged testing for shock and vibration on a mobile application has been conducted with the RAM Mount Company vehicle accessory kits which are listed in the Price Guide. The use of these kits allows the reliability of our vehicle mount rugged computers to be characterized, clearly understood and fully supported. Incorrect mounting and/or use of non-authorized mounting accessories for your computer may prematurely damage the computer and/or accessories and runs the risk of voiding the product warranty. Additional mounting instructions are contained in the DC-DC Installation Guides. Further questions can be answered by your Intermec Field Representative.

There are four mounting kit options sold separately:

- Standard Vehicle Mounting Kit (P/N 203-784-001)
- Desktop Mounting Kit (P/N 203-785-001)
- Stubby Vehicle Mounting Kit (203-783-001)
- Stubby Extra Duty Vehicle Mounting Kit (203-857-001)

For more information on installing the mounting kit, see the *CV60 Ram Mount Installation Instructions* (P/N 932-002-xxx).

## Connecting the CV60 to Power

For the CV60 to operate, you must provide power to the CV60 through a DC/DC power supply or an AC/DC power supply. You must have a power supply connected to the CV60 for it to operate.

Use the AC power supply and power cord when you are using the CV60 with a desk mounting kit.

There are four power options for the CV60. You must order one of these power options separately:

- DC/DC Converter Kit, non-heated (15-96V)  
(P/N 203-780-001)

## Chapter 1 — Using the CV60 Vehicle Mount Computer

- DC/DC Converter Kit, heated (18-96V)  
(P/N 203-780-002)
- DC/DC Power Supply Kit (6-60V)  
(P/N 203-779-001)
- CV60C AC Wall Charger Kit  
(P/N 203-787-001)

For more information on installing the DC power options, see the *Vehicle Power Supply Installation Guide* (P/N 932-003-xxx).

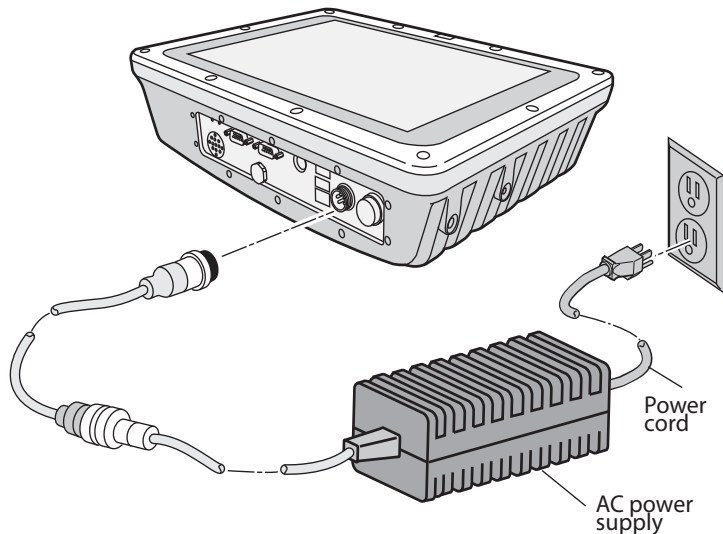

**Attaching the CV60 to Power Using an AC Power Supply**

## Understanding the Status Lights

The status lights on the CV60 turn on to indicate the status of the network connection, a successful decode of a bar code, or a user-defined function.

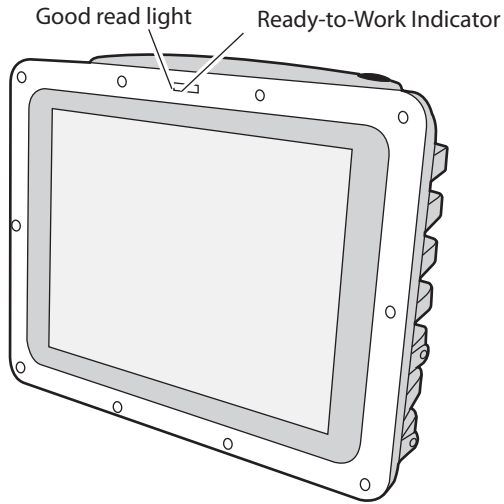

**CV60 Status Lights**

Use the table below to understand the different colors of the status lights.

**Understanding the CV60 Status Lights**

Light Name	Color	Description
Good read light	Green	This light comes on when the CV60 successfully decodes a bar code with an attached scanner.
Ready-to-Work indicator	Blue	The blue light indicates when the CV60 is ready to use in your application, typically TE 2000. If you have problems using the application, see the TE 2000 <i>Terminal Emulation Programmer's Guide</i> (P/N 977-055-xxx).

The Ready-to-Work Indicator has three states: off, blinking, and on. Use the next table to understand the different states of the light.

### Ready-to-Work Light States

Light State	What It Means
Off	The TE 2000 application has not loaded successfully, or you are not running a Ready-to-Work application.
Blinking	The CV60 is not connected to the host.
On	A connection to the server has been established and all network connections are active.

## Installing an External Antenna

You can purchase a 2.4 GHz “patch” antenna to mount on a wall, fork lift, or other flat surface using either screws or small patches of adhesive-backed hook and loop fastener material.

Since system performance and antenna polarization are site-dependent, a permanent mounting location and orientation may require some experimentation. In most fixed installations, you should mount the antenna initially in a vertically-polarized position, with the cable from the antenna parallel to the floor/ceiling.

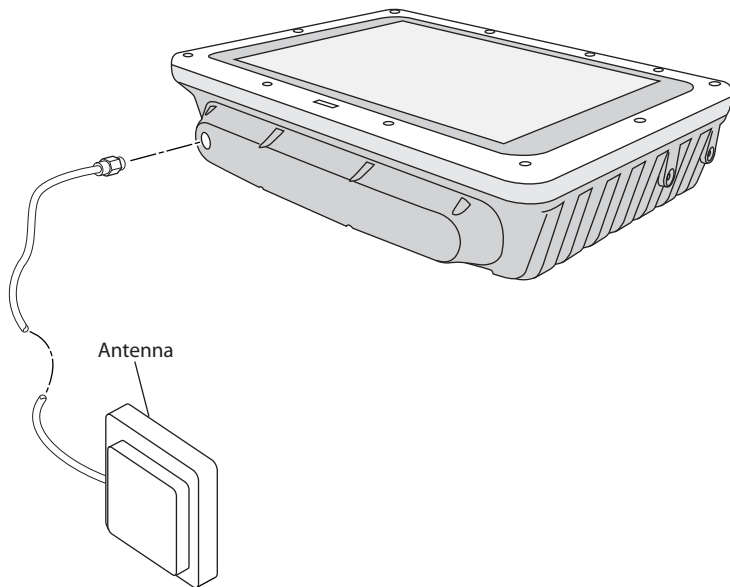

**Attaching an External Antenna**

## Attaching an External Keyboard

You can attach an external keyboard (P/N 850-551-00x) to your CV60.

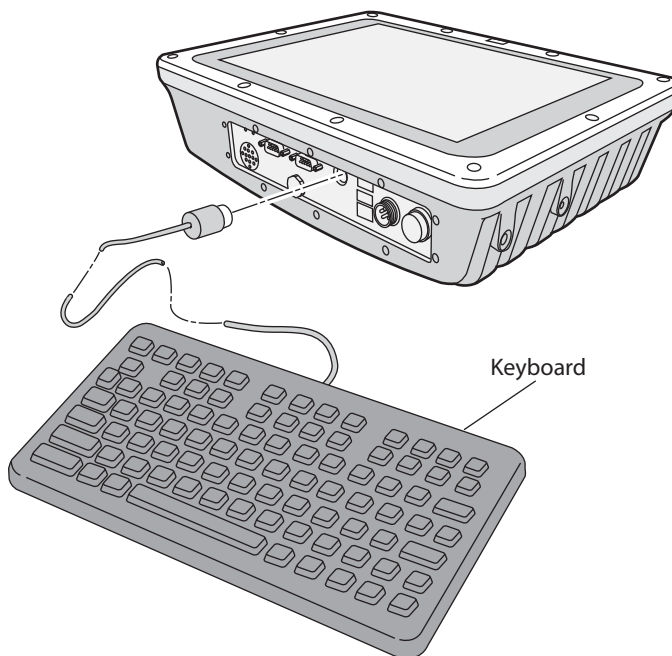

*Attaching a Rugged QWERTY Keyboard*

## Connecting a Tethered Scanner

You can attach a tethered scanner to one of the serial (COM1 or COM2) connectors on the CV60 if you order the appropriate RS-232 cable. Contact your local Intermec representative for more information.

You can also attach Bluetooth scanners to the CV60. For more information, see [“Configuring the CV60 to Communicate With a Wireless Scanner”](#) on page 26.

### **To connect a tethered scanner**

- 1 Attach the RS-232 cable to one of the COM ports on the CV60.
- 2 Attach the other end of the cable to the tethered scanner.

- 3 On the CV60, go to **Start > Settings > Control Panel > Intermec Settings**.
- 4 Go to **Data Collection > Tethered Scanner (COM1)** or **(COM2)**.
- 5 Make sure **Enable scanner port** is checked.

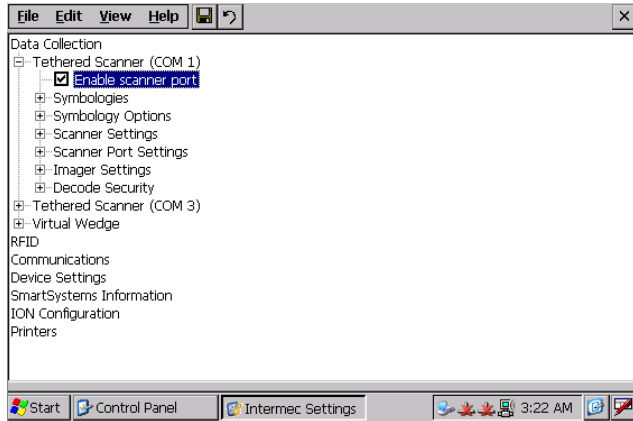

- 6 Go to **Scanner Settings > Scanner model** and select your scanner from the list.

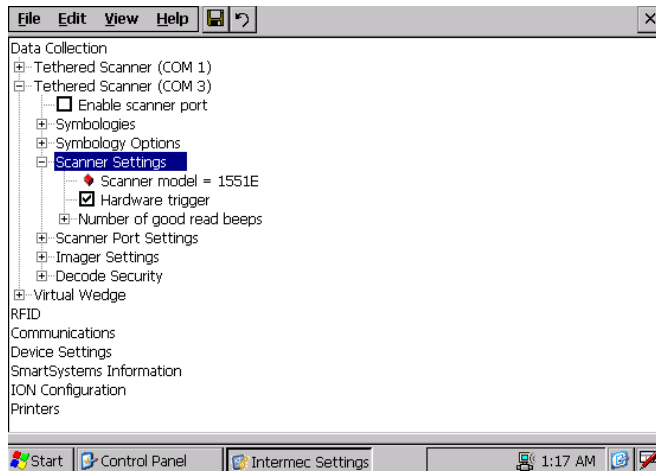

If you are configuring an ASCII scanner, you need to select **ASCII** from the Scanner model list and then configure

## **Chapter 1 — Using the CV60 Vehicle Mount Computer**

scanner port settings to match the scanner after Intermec Settings refreshes.

- 7** If you are in Windows CE Tap **File > Save Settings** or tap the disk icon ().
- 8** Depending on the scanner you are attaching, you may hear a series of beeps and the Good Read light may flash. You are now ready to use the scanner.





A decorative graphic consisting of two overlapping circles. The larger circle is on the left and the smaller one is on the right, partially overlapping the larger one. Both circles are light gray.

## **2 Understanding Windows CE**

This chapter introduces the Microsoft Windows operating system. In this Chapter you will find these sections:

- Understanding Windows CE
- Using Microsoft ActiveSync
- Using Microsoft Internet Explorer

## Understanding Windows CE

This section introduces you to Microsoft Windows CE. While using your CV60, keep these key points in mind:

- Tap **Start** on the navigation bar, located at the bottom of the screen, to quickly move to programs, files, and settings. Use the taskbar at the bottom of the screen to perform tasks in programs. The command bar includes menus, icons, and the onscreen keyboard.
- Tap and hold an item to see a pop-up menu containing a list of actions you can perform. Pop-up menus give you quick and easy access to the most common actions.

Tap **Start > Help**, then select a topic on your CV60 to find additional information on Windows CE components.

### Finding Information in Windows CE

This section describes your CV60 hardware, provides an overview of the programs on your CV60, and explains how to connect your CV60 to a desktop, a network, or the Internet. Use the following table to understand more about the CV60.

#### Finding Information in Windows CE

For Information On:	See This Source:
Programs on the CV60.	This chapter and the CV60 Help. To view Help, tap <b>Start &gt; Help</b> and then select a topic.
Connecting to and synchronizing with a desktop.	This chapter and the ActiveSync Help on your desktop. To view help, click <b>Help &gt; Microsoft ActiveSync Help</b> .
Up-to-date information on Windows CE devices.	<a href="http://msdn2.microsoft.com/en-us/embedded/default.aspx">http://msdn2.microsoft.com/en-us/embedded/default.aspx</a>

### Learning the Basic Skills

Learning to use the CV60 is easy. This section describes the basic concepts of using and customizing your CV60 Computer.

#### Using the Desktop Screen

When you turn on your CV60 for the first time each day, you see the Desktop Screen.

### To customize what displays on the desktop

- Tap **Start > Settings > Control Panel > the Display icon**.

Status icons display information such as when the CV60 is connected to the network or to the Internet. You can tap an icon to open the associated setting or program.

### Accessing Programs

You can switch from one program to another by selecting it from the Start menu. (You can customize which programs you see on this menu).

### To access programs

- Tap **Start > Programs** and then the program name.

The following is a partial list of programs that are on your CV60, in the order they appear in the Start menu.

- Internet Explorer
- Windows Media
- Microsoft WordPad

### Using the Taskbar

The taskbar is located at the bottom of the screen. It displays the Start menu icon, the current time, the Desktop icon, and the Input Panel icon. Use the taskbar to switch programs and close screens.



### Windows CE Taskbar

### Using Pop-Up Menus

Use pop-up menus to quickly perform an action on an item. For example, you can use a pop-up menu to delete or make a copy of an item. To access a pop-up menu, tap and hold the item on which you want to perform the action. When the menu appears, tap the action you want to perform, or tap anywhere outside the menu to close the menu without performing the action.

### Entering Information

You can enter information on your CV60 in several ways depending on the program you are using:

### Understanding the Ways to Enter Information

Enter Information By:	Description
Typing	Enter typed text into the CV60 by tapping keys on the onscreen keyboard or by using the handwriting recognition software.
Writing	Use the stylus to write directly on the screen.
Drawing	Use the stylus to draw directly on the screen.

Use the input panel to enter information in any program on your CV60 Computer. You can either type using the onscreen keyboard or use the optional external keyboard.

#### To show or hide the input panel

- 1 Tap the **Input Panel** (📄) icon. The Input Panel menu appears.
- 2 Choose **Keyboard** for the standard size keyboard, or choose **LargeKB** for the large keyboard.

On the soft keyboard that displays, tap the keys with your stylus. The soft keyboard works just like a standard qwerty keyboard. Here are a few tips using the soft keyboard:

- To type in lowercase letters, tap the keys with the stylus.
- To type a single uppercase letter or symbol, tap the **Shift** key. To tap multiple uppercase letters or symbols, tap the **Caps Lock** key.
- To add a space, tap the **Space** bar.
- To backspace one character, tap the **BS** key.
- To insert a carriage return, tap **return**.

#### Finding and Organizing Information

You can use Windows Explorer to find files on your CV60 and organize these files into folders.

#### To open Windows Explorer

- Select **Start > Programs > Windows Explorer**.

### Customizing the CV60

You can customize the CV60 by adjusting settings and installing additional software. Programs added to your CV60 at the factory are stored in Read Only Memory (ROM). You cannot remove this software. All other programs and files added to the CV60 after factory installation are stored in Random Access Memory (RAM).

You can install any program created for the CV60, as long as the computer has enough memory available.

## Using Microsoft ActiveSync

Use Microsoft ActiveSync to synchronize the information on your desktop with the information on the CV60. Synchronization compares the data on the CV60 with your desktop PC and updates both computers with the most recent information.



**Note:** By default, ActiveSync does not automatically synchronize all types of information. Use ActiveSync options to turn synchronization on or off for specific information types.

You can also perform these functions with ActiveSync:

- Copy files between the CV60 and the desktop.
- Back up and restore the CV60 data.
- Control when synchronization occurs by selecting a synchronization mode.
- Select which information types are synchronized and control how much data is synchronized.

### To use ActiveSync

- 1 Connect the CV60 to your desktop PC with a serial cable (P/N 321-563-003).
- 2 Install ActiveSync on your desktop. ActiveSync is available from the Microsoft web site. ActiveSync is already installed on the CV60.

After installation, ActiveSync automatically launches the ActiveSync Setup Wizard.

- 3 Follow the screens of the ActiveSync to complete the synchronization process. The wizard helps you connect to the CV60, set up a partnership for synchronization, and customizes synchronization settings.

The synchronization process automatically begins when you finish the wizard.

- 4 Disconnect the CV60 from your desktop and go to work.

Once you have set up ActiveSync and completed the first synchronization process, you can initiate synchronization from your CV60.

For more information about ActiveSync on the CV60, switch to ActiveSync, tap **Start > Help**, and then select a topic.

## **Using Internet Explorer**

You can use Internet explorer to run web-based applications and view pages downloaded to the CV60. You can also connect to the internet through an ISP or a network connection.

You can make connections using a modem, a wireless network, or Ethernet. You can use a modem connection to set up connections with an external modem.

### **To use Internet Explorer**

- 1 Set up a connection to your ISP or corporate network by going to **Start > Settings > Network** and **Dial-up Connections >** and then double-tap **Make New Connection** and follow the on-screen instructions to set up your Internet connection.
- 2 Tap **Start > Internet Explorer**. An Intermec page opens and displays the OS version loaded on the CV60.



## **3** Configuring the CV60

Use this chapter to understand how to configure the CV60 to communicate in your network. In this chapter, you will find these sections:

- Configuring CV60 Parameters
- Setting Up Serial Communications
- Setting Up Ethernet Communications
- Setting Up Bluetooth Communications
- Setting Up 802.11 Radio Communications
- Configuring Security



## Configuring CV60 Parameters

You can configure many operating parameters on the CV60, such as the symbologies it decodes or the network settings it uses. The CV60 provides a configuration application called Intermec Settings that allows you to set all of the operating parameters in one place.

### Configuring the CV60 Using Intermec Settings

Use Intermec Settings to configure the CV60 and to view system information. You access Intermec Settings from the Control Panel.

#### To open Intermec Settings

- Tap **Start > Settings > Control Panel > Intermec Settings**.

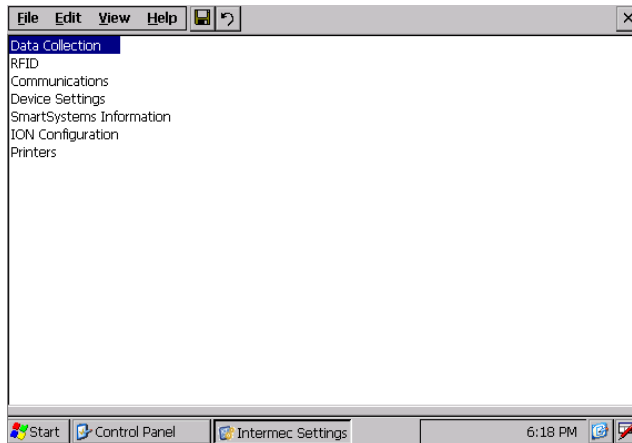

For detailed information on the commands available in Intermec Settings, see the *Intermec Computer Command Reference Manual* (P/N 073529). The *Intermec Computer Command Reference Manual* is available from the Intermec web site.

#### Navigating in Intermec Settings

To do This Function	Do This
Select or expand a command	Tap the command.
Select text in a text box	Tap in the text box and drag the stylus over the text.

**Navigating in Intermec Settings (continued)**

To do This Function	Do This
Save settings	Tap <b>File</b> > <b>Save Settings</b> or tap the disk icon (  ).

**Remotely Configuring the CV60 Using SmartSystems Foundation**

The SmartSystems™ server lets you manager all your SmartSystems-enabled devices at the same time from a central host PC. The CV60 ships with the SmartSystems client. You use the SmartSystems client with the SmartSystems server and console, which displays all of the CV60s in your network. In the console, you can right-click a CV60 and a menu appears. To configure the CV60, choose Intermec Settings from the menu.

The SmartSystems server and console are part of SmartSystems Foundation and are available from the Intermec web site. To download SmartSystems Foundation, go to [www.intermec.com/SmartSystems](http://www.intermec.com/SmartSystems). For information on how to use the SmartSystems server, see the online manual.

**Setting Up Serial Communications**

The CV60 has a serial port to transfer data to and from another device via RS-232 communications.

**To use serial communications with your CV60**

- Connect the CV60 to the serial port of another device by:
  - connecting the CV60 serial port to the serial port of the other device using the 26-pin DB9-pin serial cable and a female-to-female null modem RS-232 cable.
  - connecting the CV60 to the serial port of the other device using a DB9-pin to DB9-pin serial adapter cable.
  - connecting a USB cable between the USB connector in the CV60 and your desktop or laptop PC.

**Setting Up Ethernet Communications**

You can use the CV60 directly in an Ethernet network by connecting the network cable to the RJ45 10 BaseT/100BaseT full duplex connector on the bottom of the CV60.

### To use the CV60 in an Ethernet network

- 1 Go to **Start > Settings > Control Panel > Intermec Settings**.
- 2 If you have a DHCP server, enable DHCP.  
or  
If you do not have a DHCP server, set these parameters:
  - IP address
  - Subnet mask
  - Default router
- 3 If required for your network, you may also need to set these parameters on each CV60:
  - Primary and secondary DNS servers
  - Primary and secondary WINS servers
- 4 Make sure your CV60 is talking to the network and that the network can see your CV60.



**Note:** The easiest way to configure the network parameters on the CV60 is to use Intermec Settings. For help, see “[Configuring the CV60 Using Intermec Settings](#)” on page 22.

## Setting Up Bluetooth Communications

You can send information to a Bluetooth device wirelessly using the standard Bluetooth radio in the CV60. The Bluetooth technology uses a short-range radio links and allows for communications over a 10 meter (32.8 foot) range.



**Note:** The performance of Bluetooth varies depending on location, the Bluetooth device, and other environmental parameters.

You can use the Bluetooth radio to connect to these wireless devices:

- Scanners
- Printers
- Headsets

If your Bluetooth radio is not enabled, you can turn it on by using Intermec Settings.

**To turn the Bluetooth radio on**

- 1 Select **Start > Settings > Control Panel > Intermec Settings**.
- 2 Go to **Communications > Bluetooth > Power**.
- 3 Tap **On**. Intermec Settings prompts you to save settings.
- 4 Tap **Yes**.
- 5 Save and exit Intermec Settings.

Once Bluetooth is enabled, it stays enabled and maintains virtual COM ports (such as printing) registration. However, you must reactivate connections because these are not done automatically.

For more information on Bluetooth software, see the Bluetooth Resource Kit and the Wireless Printing Development Guide in the Intermec Developer Library (IDL). You can download this resource kit from the Intermec Developer Library web site at [www.intermec.com/idl](http://www.intermec.com/idl).

Use this table to understand the settings you see in the Bluetooth menu in Intermec Settings.

**Bluetooth Settings**

<b>Setting</b>	<b>Description</b>
Power	Set and view whether the Bluetooth radio is on or off.
Discoverable	Allows devices on your CV60 to be visible.
Connectable	Allows other Bluetooth devices to connect to your CV60.
Class of Device	Determines how the device appears to other devices during discovery.
IBT	Displays the version of the Intermec Bluetooth Library.
Radio	Displays the version of the Bluetooth Radio Hardware.
Device	Displays the Bluetooth address of your CV60.

## Configuring the CV60 to Communicate With a Wireless Scanner

This section explains how to configure the CV60 to communicate with Bluetooth wireless scanners. The CV60 ships with a Bluetooth association label attached to the left side. Scan the association label to quickly connect the CV60 to the Bluetooth wireless scanner.

If for some reason the Bluetooth association label does not work, you can follow the procedure for configuring the CV60 from Intermec Settings at the end of this section.

### To configure Bluetooth communications on the CV60

- 1 Select **Start > Settings > Control Panel > Intermec Settings**.
- 2 Select **Communications > Bluetooth**.
- 3 If you want to allow incoming connections from wireless scanners, you must enable these two parameters:
  - Discoverable
  - Connectable

If you do not want to allow incoming connections, make sure both parameters are disabled.

- 4 Save your changes and exit Intermec Settings.

### To connect to the wireless scanner using the association label

- 1 Using your wireless scanner, scan the Bluetooth association label on the side of the CV60.
- 2 The CV60 prompts you to enter the passcode for your scanner. The default passcode for Intermec Bluetooth scanners is 0000.
- 3 Tap **Finish**.

### To connect to the wireless scanner using the Bluetooth Scanner Wizard

- 1 Make sure Bluetooth communications is enabled. For help, see [“Setting Up Bluetooth Communications” on page 24](#).

- 2 Select **Start > Programs > Windows Explorer > Program Files > Intermec > Network > Bluetooth**.



- 3 Double-tap **BluetoothScannerWizard** icon. The Bluetooth Scanner Wizard appears.



- 4 Tap **Add Device**. The wizard advances to the next screen.
- 5 Select **Quick Connect (Incoming)** and tap **Next**.



- 6 Scan the bar code that appears in the dialog box.
- 7 In the **Passcode** text box, enter the passcode for your scanner. The default passcode for Intermec Bluetooth scanners are 0000.

### To remove a wireless scanner from the CV60

- 1 Select **Start > Programs > Windows Explorer > Program Files > Intermec > Network > Bluetooth > Bluetooth Scanner Wizard**.
- 2 Tap **Remove Device**.
- 3 Select the Bluetooth scanner from the DCE Device(s) list that you want to disconnect and then tap **Disconnect**.  
The scanner you wanted to remove no longer appears in the list.
- 4 Tap **Finish**.

## Configuring for Wireless Printing in Windows

This section explains how to configure the CV60 for Bluetooth Wireless printing. You need to:

- make sure Bluetooth power is on. For help, “[Setting Up Bluetooth Communications](#)” on page 24.
- select the current wireless printer on the CV60. For help, see “[Selecting the Current Wireless Printer on the CV60](#)” on page 29.

### Using the Wireless Printing Applet to Select a Printer

The Wireless Printing applet is available from **Start > Settings > Control Panel**. The applet separates the task of wireless printing setup from other Bluetooth management tasks.

The Wireless Printing applet uses the concept of a “current wireless printer.” The CV60 connects to the current wireless printer when your application opens the wireless printing COM port on the CV60. If there is no current wireless printer selected on your CV60, there is no wireless printer COM port registered on your CV60. You must select a current wireless printer on your CV60, as described in the next section.

The Wireless Printing applet performs these tasks on the CV60:

- Helps you select the current wireless printer
- Stores the current wireless printer in the registry
- Register/deregisters the wireless printing COM port

- Stores the wireless printing COM port in the registry as the Wport

Specifically, the current wireless printer is registered and deregistered on Bluetooth stack load/unload. If you select a different current wireless printer, the existing wireless printing COM port is deregistered and the new one is registered instead. The Wireless Printing applet uses the Bluetooth COM Port Control to handle COM port registration/deregistration.

### **Selecting the Current Wireless Printer on the CV60**

By default, there is no current wireless printer selected on the CV60.

There are three ways to select the current wireless printer:

- Discovering the printer using Bluetooth Device discovery
- Manually entering the printer's Bluetooth device address
- Choosing the printer from a list of previously discovered printers

#### **To discover the printer with Bluetooth device discovery**



- 1 Select **Start > Settings > Control Panel > Wireless Printing**. The Wireless Printing wizard appears.
- 2 Select the **Device Discovery** button and tap **Acquire Printer**. All Bluetooth devices discovered within range appears in the devices list.
- 3 Select the printer you want and then tap **OK**.

If your preferred printer does not appear, make sure the printer is turned on and discovery is enabled, and then repeat Steps 1 through 3.

#### **To manually enter the device address of the printer**



- 1 Select **Start > Settings > Control Panel > Wireless Printing**. The Wireless Printing wizard appears.
- 2 Select the **Manual** button and tap **Acquire Printer**. The wizard advances to the next screen where you enter the device address.



- 3 Type the address of the printer in the Enter Device Address text box and then tap **OK**. The keyword -unknown- appears in the Device Name field in the Current Wireless Printer box.
- 4 The name of the printer is not sent to the CV60 when you manually enter the printer address.

#### To choose the printer from a list of previously discovered devices

- 1 Make sure that you have already performed a Bluetooth device discovery.



- 2 Select **Start > Settings > Control Panel > Wireless Printing**. The Wireless Printing wizard appears.
- 3 Select the **Device Manager** button and tap **Acquire Printer**. The Device Manager screen appears with the list of previously discovered devices.
- 4 Select the printer you want and tap **OK**.

## Setting Up 802.11 Radio Communications

The CV60 comes with an optional 802.11 b/g or 802.11 a/b/g radio to transfer data using wireless communications.

If you have a CV60 with an 802.11 a/b/g radio, you can set the band which you want to operate at.

#### To configure the 802.11 band on the CV60

- 1 Go to **Start > Settings > Control Panel > Intermec Settings > Communications > 802.11 Radio > Radio Bands**.
- 2 From here you can choose **a/b/g (2.4 and 5 GHz)** to allow dual band operation, **b/g (2.4 GHz)** for b/g band only operation, or **a (5.0 GHz)** for a band only operation.
- 3 Tap **File > Save Settings** or tap the disk icon (  ) to save your settings and exit.

## Configuring the Network Parameters for a TCP/IP Network

This section of the manual assumes that you have already set up your wireless communications network including your access points. If you are using a UDP plus network, you also need to have your Intermec Application Server communicating with a host computer.

The CV60 support these network protocols:

- TCP/IP
- UDP Plus

In a TCP/IP network, the CV60 communicates with a host computer directly using TCP/IP. The access point acts as a bridge to allow communications between the wired network and the wireless network.

### To use wireless communications in a TCP/IP network

- 1 Go to **Start > Settings > Control Panel > Intermec Settings**.
- 2 Configure these network parameters on each CV60 in the network:
  - Network name (SSID)
  - IP settings (if not using DHCP)
- 3 Configure security. For help see, [“Configuring Security on the CV60” on page 32](#).
- 4 Make sure that the CV60 is talking to the network and that the network can see the CV60.

The easiest way to configure the network parameters on the CV60 is to use Intermec Settings. For help, see [“Configuring the CV60 Using Intermec Settings” on page 22](#).

## Configuring the Network Parameters for a UDP Plus Network

In a UDP Plus network, the CV60 communicates with a host computer through the Intermec Application Server. The Intermec Application Server translates UDP Plus packets on the wireless network into TCP/IP packets on the wired network and vice versa. An access point acts as a bridge to allow communications between the wired network and the wireless network.

### To use wireless communications in a UDP Plus network

- 1 Go to **Intermec Settings > Communications > UDP Plus**.
- 2 Configure these network parameters on each CV60 in the network:
  - Network name (SSID)

- Controller IP address
- IP settings (if not using DHCP)
- 3** Configure security. For help see, “[Configuring Security on the CV60](#)” on page 32.
- 4** Make sure that the CV60 is talking to the network and that the network can see the CV60.

## **Configuring Security on the CV60**

The CV60 provides three types of security for your wireless network:

- Wi-Fi Protected Access (WPA)
- Wi-Fi Protected Access 2 (WPA2)
- WEP

This section explains how to configure security on your wireless CV60. If you choose not to use security, see “[Disabling Security](#)” on page 57. Intermec always recommends that you implement security.

You must use either Funk or Microsoft security to implement your security solution. For details, see “[Choosing Between Funk and Microsoft Security](#)” on page 35.

If you are using WPA-802.1x, WPA2-802.1x, or 802.1x WEP security, this section assumes that your authentication server and authenticators are properly configured.

## **Understanding the Wireless Network**

Your wireless radio adapter (network interface card) connects to wireless networks of two types: infrastructure and ad-hoc networks.

- Infrastructure networks get you onto your corporate network and the internet. The CV60 establishes a wireless connection to an access point, which links you to the rest of the network. When you connect to a network using an access point, you are using the 802.11 infrastructure mode.
- Ad-hoc networks are private networks shared between two or more clients.

Each wireless network is assigned a name or SSID (Service Set Identifier) to allow multiple networks to exist in the same area without infringing on each other.

Intermec recommends using security with wireless networks to prevent unauthorized access to your network and to ensure that privacy of transmitted data. Authentication by both the network and the user are required elements for secure networks.

## **Using WPA Security**

Wi-Fi Protected Access (WPA) is a strongly enhanced, interoperable Wi-Fi security that addresses many of the vulnerabilities of Wired Equivalent Privacy (WEP). Instead of WEP, WPA uses Temporal Key Integrity Protocol (TKIP) for its data encryption method.

Currently, WPA satisfies some of the requirements in the IEEE 802.11i draft standard. When the standard is finalized, WPA will maintain forward compatibility.

WPA runs in 802.1x (Enterprise) mode or PSK (Pre-Shared Key) mode:

- In Enterprise mode, WPA provides user authentication using 802.1x and an Extensible Authentication Protocol (EAP). That is, an authentication server (such as a RADIUS server) must authenticate each device before the device can communicate with the wireless network.
- In PSK mode, WPA provides user authentication using a shared key between the authenticator and the CV60. WPA-PSK is a good solution for small offices or home offices that do not want to use an authentication server.

To use WPA security, you need:

- an authentication server (Enterprise mode only).
- an access point with an 802.11 b/g or a/b/g radio that supports WPA.
- a CV60 with the 802.11 b/g or a/b/g radio and the 802.1x/WPA security option.

The CV60 also supports Wi-Fi Protected Access 2 (WPA2) if you are using Funk security. WPA2 uses an Advanced Encryption Standard (AES) for data encryption.

WPA2 runs in 802.1x (Enterprise) mode or PSK (Pre-Shared Key) mode:

- For WPA2-802.1x mode, WPA2 requires authentication in two phases; the first is an open system authentication and the second uses 802.1x and an Extensible Authentication Protocol (EAP) authentication method.
- In PSK mode, WPA2 provides user authentication using a shared key between the authenticator and the CV60. WPA2-PSK is a good solution for small offices or home offices that do not want to use an authentication server.

### Using 802.1x Security

802.1x security provides centralized user authentication using an authentication server, authenticators (access points), and supplicants (wireless devices). These components communicate using an EAP authentication type, such as TLS (Transport Layer Security) or PEAP (Protected Extensible Authentication Protocol). 802.1x security provides data encryption using dynamic key management.

To use 802.1x security, you need:

- an access point with an 802.11b/g or a/b/g radio.
- a CV60 with an 802.11b/g or a/b/g radio.
- an authentication server.

### Using LEAP Security

Lightweight Extensible Authentication Protocol (LEAP), also known as Cisco-Wireless EAP, provides username/password-based authentication between a wireless client and a RADIUS server. In the 802.1x framework, traffic cannot pass through an Ethernet hub or wireless network access point until it successfully authenticates itself.

The station must identify itself and prove that it is an authorized user before it is actually allowed to use the LAN. LEAP also delivers a session key to the authenticated station, so that future frames can be encrypted with a key that is different than keys used by other sessions.

To use LEAP security, you need:

- a RADIUS server.
- Cisco access points.

LEAP security is not supported with Microsoft security.

## **Using Static WEP Security**

The CV60 uses the Wired Equivalent Privacy (WEP) protocol to add security to your wireless network based on the 802.11 standard.

To use WEP security, you need:

- a CV60 with an 802.11b/g or a/b/g radio.
- an access point with an 802.11b/g or a/b/g radio.

## **Choosing Between Funk and Microsoft Security**

The CV60 provides both Funk and Microsoft security choices. Funk security is the default setting. Use the following sections to set security using either Funk or Microsoft as your security choice. Both security choices offer similar features, but Funk security also offers these features:

- CCX v3 compliance.
- Configuration for up to four profiles.
- The greater compatibility of authentication servers with more authentication choices.

Funk security is the default setting. For help, see [“Configuring the CV60 Using Intermec Settings” on page 22](#) or [“Configuring Funk Security Using Intermec Settings” on page 35](#).

If you want to use Microsoft security, you need to select it as your security choice. For help, [“Configuring Microsoft Security” on page 51](#).

### **Configuring Funk Security Using Intermec Settings**

You can define up to four profiles for Funk security. Different profiles let your CV60 communicate in different networks without having to change all of your security settings. For example, you may want to set up one profile for the manufacturing floor and one for the warehouse. By default, the active profile is Profile\_1.

### To select a profile for Funk Security

- 1 Select **Start > Settings > Control Panel > Intermec Settings**.
- 2 Select **Communications > 802.11 Radio > Funk Security**.

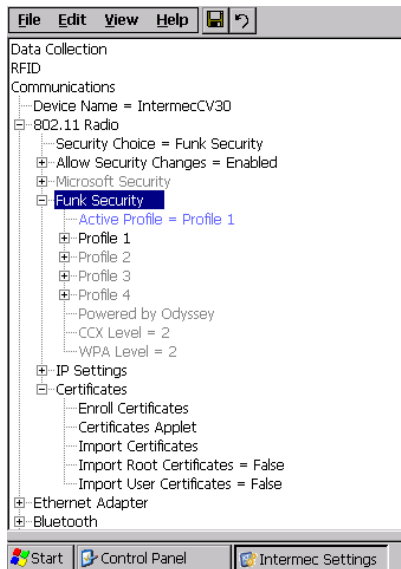

- 3 Select **Active Profile**, choose a profile from the list, and save your settings.
- 4 Tap the active profile to expand it.
- 5 (Optional) Give your profile a meaningful name:
  - a Select **Profile Label** and a text box appears.
  - b Select the text in the box and type in a meaningful name.
- 6 Select one profile as the active profile by tapping Active Profile and choosing a profile from the drop-down list.
- 7 Save your settings.

### Configuring WPA Security With Funk Security

Use these procedures to set WPA802.1x, WPA2-802.1x, WPA-PSK, or WPA2-PSK security on your CV60 with Funk security.

#### To configure WPA-802x1x or WPA2-802.1x with Funk security

- 1 Open Intermec Settings.

- 2 Make sure you have configured the communications parameters and selected Funk as your security choice.
- 3 Choose **Communications > 802.11 Radio > Funk Security > Profile**.
- 4 For **Association**, choose **WPA** or **WPA2** and press **Enter**. Encryption automatically defaults to TKIP if you are using WPA. Encryption automatically defaults to AES if you are using WPA2.

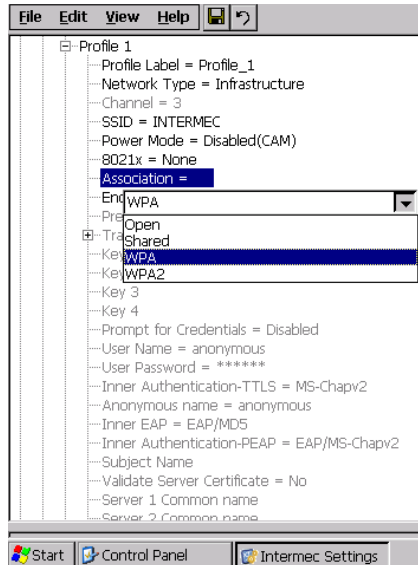

- 5 For **8021x**, choose **TTLS**, **PEAP**, **EAP-FAST**, or **TLS** and press **Enter**.

If you choose TTLS or PEAP:

- a For Prompt for Credentials, choose **Enter credentials now**.



**Note:** You can use **Prompt for credentials** to troubleshoot your connection to the network if you have problems. By choosing **Enter credentials now**, you are storing the user name and password on the device so that you will not need to enter it every time.

- b Select **User name** and type your user name.



- c Select **User Password** and type a user password.
- d For **Validate Server Certificate**, choose **Yes**.



**Note:** You must have the date on the CV60 set correctly when you enable Validate Server Certificate.

If you choose TLS:

- a Load a user and root certificate on your CV60. For help, see cross reference.
- b For **Validate Server Certificate**, choose **Yes**.

You must enter a **User Name** and **Subject Name**. You can also enter a **Server Common Name** if you want to increase your level of security.

- 6 Save your settings.

#### To enable WPA-PSK or WPA2-PSK with Funk security

- 1 Open Intermec Settings.
- 2 Make sure you have configured the communications parameters and selected Funk as your security choice.
- 3 Choose **Communications > 802.11 Radio > Funk Security > Profile**.
- 4 For **Association**, choose **WPA** or **WPA2**.
- 5 For **8021x**, choose **None**.
- 6 For **Pre-Shared Key**, enter the pre-shared key or the passphrase.

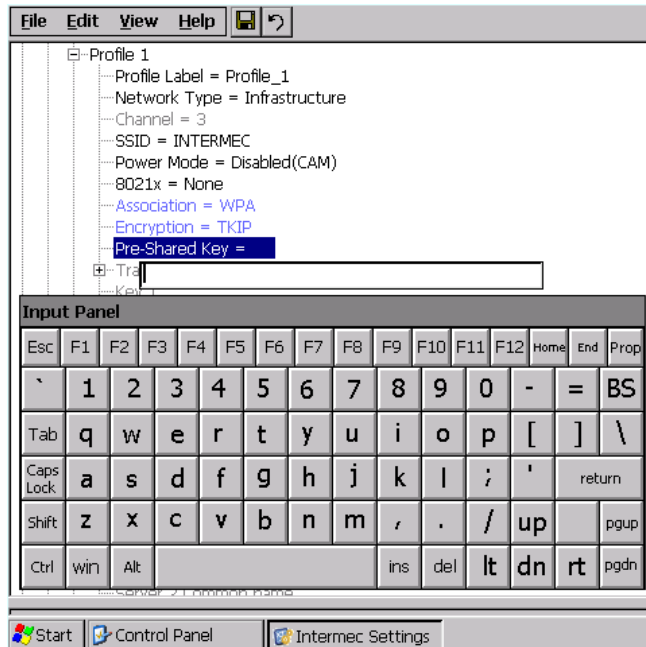

The pre-shared key may be given in hexadecimal by prefixing a string of 64 hex digits with 0x for a total of 66 characters, or by entering a passphrase of 8 to 63 characters.

The pre-shared key value must exactly match the key on the authenticator.

7 Save your settings.

### Configuring 802.1x Security With Funk Security

- 1 Open Intermec Settings.
- 2 Make sure you have configured the communications parameters and selected Funk as your security choice.
- 3 Choose **Communications > 802.11 Radio > Funk Security > Profile**.
- 4 For **Association**, choose **Open**.
- 5 For **Encryption**, choose **WEP**.
- 6 For **Authentication**, choose **TTLS, PEAP, or TLS**.

If you choose TTLS or PEAP:

- a Select **User name** and type your user name.
- b Select **Password prompt**, and choose **Enter password now**.



**Note:** You can use **Prompt for password** to troubleshoot your connection to the network if you have problems.

- c Select **User Password** and type a user password.
- d For **Validate Server Certificate**, choose **Enabled**.

If you choose TLS:

- a Load a user and root certificate on your CV60. For help, see [“Loading a Certificate” on page 54](#).
- b For **Validate Server Certificate**, choose **Yes**.
- c You must enter a **User Name** and **Subject Name**. You can also enter a **Server Common Name** if you want to increase your level of security.

7 Save your settings.

### Configuring LEAP Security With Funk Security

- 1 Open Intermec Settings.
- 2 Make sure you have configured the communications parameters and selected Funk as your security choice.
- 3 From Intermec Settings, choose **Communications > 802.11 Radio > Funk Security > Profile**.
- 4 For **8021x**, choose **LEAP**.
- 5 For **Association**, choose **Open, WPA, WPA2, or Network EAP**. Encryption automatically defaults to TKIP if you choose WPA, to AES if you choose WPA2, and to WEP if you choose Open or Network EAP.
- 6 For **Prompt for Credentials**, choose **Enter credentials now**.
- 7 Select **User name** and type your user name.
- 8 Select **User Password** and type a user password.
- 9 Save your settings.

### Configuring Static WEP Security With Funk Security

- 1 Open Intermecc Settings.
- 2 Make sure you have configured the communications parameters and selected Funk as your security choice.
- 3 Choose **Communications > 802.11 Radio > Funk Security > Profile**.
- 4 For **Association**, choose **Open**.
- 5 For **Encryption**, choose **WEP**.
- 6 For **8021x**, choose **None**.
- 7 Define a value for the keys you want to use. You can define up to four keys (**Key 1** through **Key 4**).

Enter an ASCII key or a hex key that is either 5 bytes or 13 bytes long depending on the capability of the radio. Set a 5-byte value for 64-bit WEP or a 13-byte value for 128-bit WEP. Hex keys must be preceded by 0x and contain 5 or 13 hex pairs.

- 8 For **Transmit key**, choose the key you want to use for transmitting data.
- 9 Save your settings.

### Configuring Funk Security Using the Profile Wizard

You can start 802.11 communications on the CV60 using the Profile Wizard. A profile contains all the information necessary to authenticate you to the network, such as login name, password or certificate, and protocols by which the CV60 is authenticated. You can have up to four profiles for different networks. For example, you may have different login names or passwords on different networks.

#### To select a profile for Funk security

- 1 Select **Start > Settings > Control Panel > Wireless Network**.

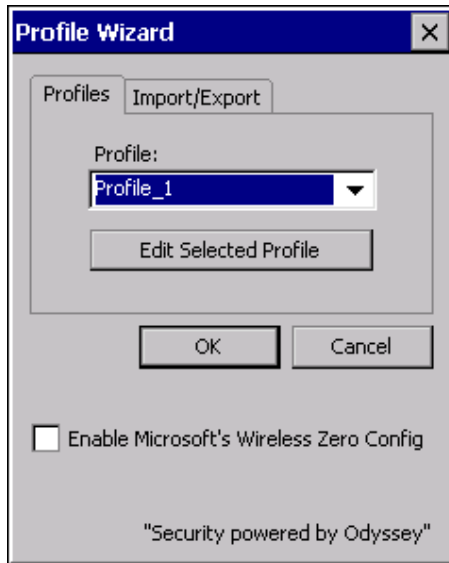

The Profile Wizard appears on the screen.

- 2 From the **Profile** list, select the profile you want to configure.
- 3 Tap **Edit Selected Profile**.
- 4 (Optional) Give your profile a meaningful name by selecting the text in the Profile Label text box and typing in the name you want for your profile.
- 5 From the **Network type** list, select either **Infrastructure** or **Ad-Hoc**. Select Infrastructure if the network uses access points to connect to the corporate network or internet. Select Ad-Hoc to set up a private network with one or more participants.
- 6 Enter the **SSID (Network Name)**.
- 7 Tap **OK**.

#### **Configuring WEP Security With Profile Wizard**

- 1 In the Profile Wizard, select the **Security** tab.



- 2 For **8021x Security**, choose **None**.
- 3 For **Association**, choose **Open** or **Shared** to match the settings on your access point.
- 4 For **Encryption**, choose **WEP**.
- 5 From the **DataTX Key** list, select the key you want to use for transmitting data.
- 6 Define a value for the keys you want to use. You can define up to four keys (**Key 1** through **Key 4**).

Enter an ASCII key or a hex key that is either 5 bytes or 13 bytes long depending on the capability of the radio. Set a 5-byte value for 64-bit WEP or a 14-byte value for 128-bit WEP. Hex keys must be preceded by 0x and contain 5 or 13 hex pairs.

- 7 Tap **OK**.

### Configuring WPA-PSK Security With Profile Wizard

- 1 In the Profile Wizard, select the **Security** page.
- 2 For **8021x Security**, Choose **None**.
- 3 For **Association**, Choose **WPA**.

- 4 For the **Pre-Shared Key** field, enter the passphrase as ASCII. The passphrase must be 8 to 63 characters and match the passphrase on the access point.
- 5 Tap **OK**.

### Configuring WPA2-PSK Security With Profile Wizard

- 1 In the Profile Wizard, select the **Security** page.
- 2 For **8021x Security**, choose **None**.
- 3 For **Association**, choose **WPA2**.
- 4 For Encryption, choose **TKIP** or **AES**.
- 5 For the **Pre-Shared Key** field, enter the passphrase as ASCII. The passphrase must be 8 to 63 characters and match the passphrase on the access point.
- 6 Tap **OK**.

### Configuring PEAP Security With Profile Wizard

Protected EAP (PEAP) performs secure authentication against Windows domains and directory services. It is comparable to EAP-TTLS, though it is not as flexible.

#### To configure PEAP security

- 1 In the Profile Wizard, select the **Security** tab.



- 2 For **8021x Security**, choose **PEAP**.
- 3 For **Association**, choose **Open**, **WPA**, **WPA2**, or **Network EAP**.
- 4 For **Encryption**, choose **TKIP** or **AES** if you selected WPA2 for association, or **WEP** or **CKIP** if you selected Network EAP for association.
- 5 For **Username**, type a unique username for this protocol.
- 6 Select **Prompt for password** to have the user enter this password each time to access the protocol, or select **Use following password** to use the protocol without entering a password each time you use the CV60.
- 7 In the **Password** field, type a unique password for this protocol.
- 8 Tap **Get Certificates** to obtain or import server certificates. For help with certificates, see
- 9 Tap **Additional Settings** to assign an inner PEAP authentication and set options for server certificate validation and trust.
- 10 From the **Inner PEAP Authentication** list, choose **EAP/MS-CHAP-V2**, **EAT/Token Card**, or **EAP/MD5-Challenge**.
- 11 Check **Validate Server Certificate** to verify the identity of authentication server based on its certificate when using PEAP.
- 12 Tap **Root CA**, select a root certificate, and then tap **OK**.
- 13 Enter the Common Names of trusted servers.
- 14 Tap **OK**.

### Configuring TLS Security With Profile Wizard

EAP-TLS is a protocol based on the Transport Layer Security (TLS) protocol widely used to secure web sites. This protocol requires both the user and authentication server to have certificates for mutual authentication.

#### To configure TLS security

- 1 In the Profile Wizard, select the **Security** tab.





- 2 For **8021x Security**, choose **TLS**.
- 3 For **Association**, choose **Open**, **WPA**, **WPA2**, or **Network EAP**.
- 4 For **Encryption**, choose **TKIP** or **AES** if you selected WPA2 for association, or **WEP** or **CKIP** if you selected Network EAP for association.
- 5 For **Subject Name**, type a unique subject name for this protocol.
- 6 For **User Name**, type a unique user name for this protocol.
- 7 Tap **Get Certificates** to obtain or import server certificates/ For help with certificates, see
- 8 Tap **Additional Settings** to server certificate validation and trust.
- 9 Check **Validate Server Certificate** to verify the identity of the authentication server based on its certificate when using TLS.
- 10 Tap **Root CA**, select a root certificate, and then tap **OK**.
- 11 Enter the Common Names of trusted servers.
- 12 Tap **OK**.

### Configuring TTLS Security With Profile Wizard

TTLS (Technical Translation and Localization Services) protocol provides authentication like EAP-TLS but does not require user certificates. User authentication is done using a password or other credentials that are transported in a securely encrypted “tunnel” established using server certificates.

#### To configure TTLS security

- 1 In the Profile Wizard, select the **Security** tab.

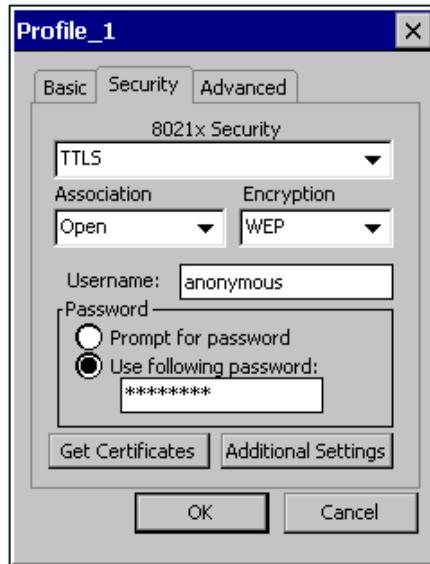

- 2 For **8021x Security**, choose **TTLS**.
- 3 For **Association**, choose Open, WPA, WPA2, or Network EAP.
- 4 For **Encryption**, choose **TKIP** or **AES** if you selected WPA2 for association, or **WEP** or **CKIP** if you selected Network EAP for association.
- 5 For **User Name**, type a unique user name for this protocol.
- 6 In the **Password** field, type a unique password for this protocol.
- 7 Select **Prompt for password** to have the user enter this password each time to access the protocol, or select **Use**

**following password** to use the protocol without entering a password each time you use the CV60.

- 8** (Optional) Tap **Get Certificates** to obtain or import server certificates. For help with certificates, see [“Loading a Certificate” on page 54](#).
- 9** Tap **Additional Settings** to assign an inner TTLS authentication, inner EAP, and set options for server certificate validation and trust.
- 10** From the **Inner TTLS Authentication** list, choose **PAP, CHAP, MS-CHAP, MS-CHAP-V2, PAP/Token Card, or EAP**.
- 11** If you select EAP for the inner authentication protocol, select an inner EAP protocol from the **Inner EAP** list.
- 12** Check **Validate Server Certificate** to verify the identity of the authentication server based on its certificate when using TTLS.
- 13** Tap **Root CA**, select a root certificate, and then tap **OK**.
- 14** Enter the Common Names of trusted servers.
- 15** For **Anonymous EAP-TTLS Name**, type an outer identity to protect your login name or identity.
- 16** Tap **OK**.

### **Configuring LEAP Security With Profile Wizard**

LEAP is the Cisco Lightweight version of EAP.

#### **To configure LEAP security**

- 1** In the Profile Wizard, select the **Security** page.



- 2 For **8021x Security**, choose **LEAP**.
- 3 For **Association**, choose **Open**, **WPA**, **WPA2**, or **Network EAP**.
- 4 For **Encryption**, choose **TKIP** or **AES** if you selected WPA2 for association, or **WEP** or **CKIP** if you selected Network EAP for association.
- 5 For **Username**, type a unique username for this protocol.
- 6 In the **Password** field, type a unique password for this protocol.
- 7 Select **Prompt for password** to have the user enter this password each time to access the protocol, or select **Use following password** to use the protocol without entering a password each time you use the CV60.
- 8 Tap **OK**.

### **Configuring EAP-FAST with Profile Wizard**

The EAP-FAST protocol is a client-server security architecture that encrypts EAP transactions with a TLS tunnel. While similar to PEAP, EAP-FAST differs significantly since tunnel establishment is based on Protected Access Credentials (PACs), which CiscoSecure ACS generates using a master key known only to CiscoSecure ACS. EAP-FAST does not require certificate management.

#### **To configure EAP-FAST with Profile Wizard**

- 1** In the Profile Wizard, select the **Security** page.
- 2** For **8021x Security**, choose **EAP-FAST**.
- 3** For **Association**, choose **Open**, **WPA**, **WPA2**, or **Network EAP**.
- 4** For **Encryption**, choose **WEP** or **CKIP** if you selected Network EAP for association.
- 5** For **Username**, type a unique username for this protocol.
- 6** In the **Password** field, type a unique password for this protocol.
- 7** Select **Prompt for password** to have the user enter this password each time to access the protocol, or select **Use following password** to use the protocol without entering a password each time you use the CV60.
- 8** Tap **Additional Settings** to set options for PAC management and assign an anonymous EAP-FAST name.

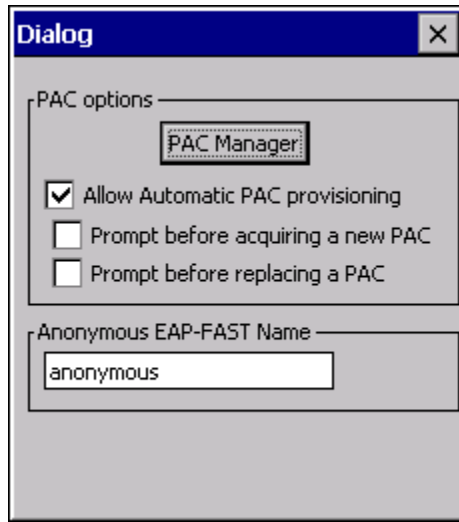

- 9 Tap **PAC Manager** to view the PAC files currently installed on the CV60. Tap **ok** to return to the Additional Settings screen.
- 10 If you already have a PAC on the CV60, clear **Allow Automatic PAC provisioning** to avoid receiving more PACs from the server.
- 11 If **Allow Automatic PAC provisioning** is selected, you can check:
  - **Prompt before acquiring a new PAC** for notification of any incoming PACs.
  - **Prompt before replacing a PAC** for notification whether to replace a current PAC with an incoming PAC.
- 12 For **Anonymous EAP-FAST Name**, type the outer identity assigned for public usage.
- 13 Tap **OK**.

### Configuring Microsoft Security

The default security setting is Funk. If you want to use Microsoft security, you need to select it as your security choice. After you select Microsoft as your security choice, you will be prompted to save your settings and reset your computer for your change to take effect.

**To select Microsoft security as your security choice**

- 1** Select **Start > Settings > Control Panel > Intermec Settings**. The Intermec Settings application appears.
- 2** Select **Communications > 802.11 Radio > Security Choice**.
- 3** From the Security Choice list, select **Microsoft Security** and save your settings. An alert box appears telling you that you must save your settings and reboot the CV60 for the new security choice to take effect.
- 4** Tap **Yes**. The CV60 resets and starts with Microsoft Security as the Security Choice.

Networks already configured are preferred networks. You can connect to only preferred networks or search for and connect to any available network.

You can add a wireless network when the network is detected or manually by entering settings information. To determine if authentication information is needed, see your network administrator.

When the CV60 restarts with Microsoft selected as the security choice, a dialog box with your wireless network information appears. You can connect to an existing preferred connection or set up a new connection. The following information is for setting up a new connection.

**To configure Microsoft security for a new connection**

- 1** In the radio network connection dialog box, double-tap **Add New**.

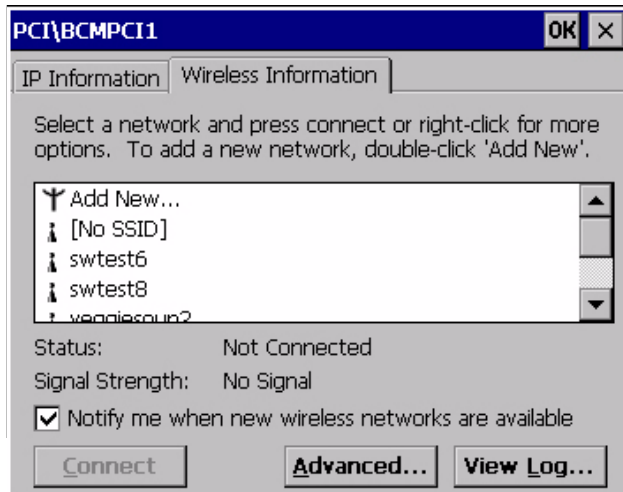

The Wireless Network Properties dialog box appears.

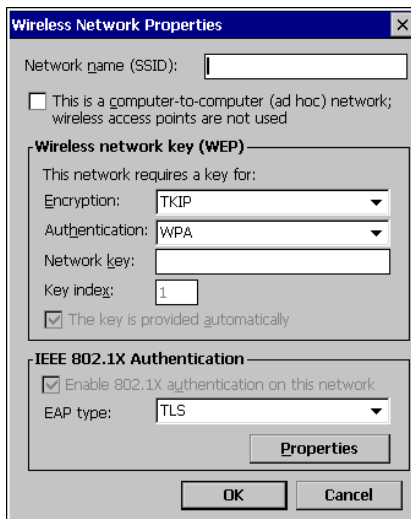

- 2 Enter a network name. If the network was detected, the network name is entered and cannot be changed.
- 3 (Optional) To connect to an ad-hoc connection, select **This is a computer-to-computer (ad-hoc) network; wireless access points are not used**.
- 4 Follow these steps to disable authentication:



- a Set **Authentication** to **Open** if WEP keys are not required or to **Shared** when WEP keys are required for association.
- b Set **Data Encryption** to **Disabled**.

Follow these steps to enable WEP encryption:

- a Set **Authentication** to **Open** if WEP keys are not required or to **Shared** when WEP keys are required for association.
- b Set **Data Encryption** to **WEP**.
- c To change the network key, clear **The key is provided automatically** check box, enter the new **Network key**, and then select the appropriate **Key index**.

Follow these steps to enable WPA authentication:

- a Set **Authentication** to **WPA**.
- b Set **Data Encryption** to either **WEP** or **TKIP**.

Follow these steps to enable WPA authentication using a preshared key:

- a Set **Authentication** to **WPA-PSK**.
  - b Set **Data Encryption** to either **WEP** or **TKIP**.
  - c Enter the new **Network key**.
- 5 From the **EAP type** list, select either **MD5-Challenge**, **PEAP** or **TLS**.
  - 6 Tap **OK** to close the screen.



**Note:** If you select to automatically connect to non-preferred networks, the CV60 detects any new networks and provides you with the opportunity to configure them.

## Loading a Certificate

If you choose to use transport layer security (TLS) with WPA or 802.1x security, you need to have a unique client certificate on the CV60 and a trusted root certificate authority (CA) certificate. You can use a third-party CA to issue unique client certificates and a root certificate.

There are three ways to load certificates on the CV60:

- If you are using Active Directory to issue certificates, you can use the Enroll Certificates application to load the certificates.
- If you are using another third-party CA, you can use the Import Certificates application to load the certificates.
- If you have multiple certificates to install, you can use the Import Root Certificates and Import User Certificates functions.



**Note:** For certificates to be valid, the CV60 must be set to the correct date and time.

### To load certificates if you are using Active Directory

- 1 Configure the network and radio settings for the CV60 to communicate with your certificate authority or establish an ActiveSync connection with the CA.
- 2 From Intermec Settings, select **Communications > 802.11 Radio > Certificates**.
- 3 Select **Enroll Certificates** and tap the **Run App** button. The Enroll Certificates dialog box appears.
- 4 In the Enroll Certificates dialog box, enter the **User Name**, **Password**, and **Server** (IP address) to log into the CA server.
- 5 Tap **OK**. A dialog box appears asking if you want to load the root certificate.
- 6 Tap **OK** for yes. The Enrollment Tool message box appears telling you that the user certificate has been added.
- 7 Tap **OK** to close the Enrollment Tool message box.
- 8 Configure your CV60 for WEP, WPA, or WPA2 security.

### To load certificates if you are using a third-party CA

- 1 From Intermec Settings, select **Communications > 802.11 Radio > Certificates**.
- 2 Select **Import Certificates** and tap the **Run App** button. The certificates application appears.
- 3 Tap  in the Import Root Certificate box and navigate to your private .cer file.

- 4 Select the file and the path to your .cer file now appears in the text box.
- 5 Tap **Import Certificate**. A dialog box appears asking if you want to add the certificate to the root store.
- 6 Press **OK** to add the certificate. A message box appears telling you that the root certificate has been imported.
- 7 Tap **OK** to close the Success message box.
- 8 Tap **Import User Cert**. A dialog box appears telling you that the user certificate and the associated key were successfully imported.
- 9 Tap **OK** to close the Success message box.
- 10 Configure your CV60 for WEP, WPA, or WPA2 security.

#### To load multiple certificates

- 1 Create the \Temp\Root and the \Temp\User folders on the CV60.
- 2 Copy at least one root certificate .cer file into the \Temp\Root folder.
- 3 Copy at least one user certificate .cer file and key .pvk file into the \Temp\User folder. The filenames must match (for example, cert1.cer and cert1.pvk).
- 4 From Intermec Settings, select **Communications > 802.11 Radio > Certificates**.
- 5 Select **Import Root Certificates**. Choose **True** from the drop-down menu.
- 6 Select **Import User Certificates**. Choose **True** from the drop-down menu.
- 7 Save your settings and exit Intermec Settings. The certificates are immediately imported:
  - a All root certificates in \Temp\Root are imported into the Trusted Authorities certificate store.



**Note:** You are prompted when a root certificate is imported, unless that certificate is already in the store.

- b** All certificate and key files in \Temp\User are imported into the My Certificates certificate store.
  - c** The Import Root Certificates and the Import User Certificates settings are changed from **True** to **False**.
- 8** Configure your CV60 for WEP, WPA, or WPA2 security.

## **Disabling Security**

If you choose not to use security with your wireless network, you can disable it on the CV60. Intermec recommends that you always set security in your network.

### **To disable security**

- 1** Open Intermec Settings.
- 2** Choose **Communications > 802.11 Radio > Microsoft Security**.
- 3** For **Network Authentication**, choose **Open**.
- 4** For **Data Encryption**, choose **Disabled**.
- 5** Save and exit Intermec Settings.



A decorative graphic consisting of two overlapping circles. The larger circle is light gray and partially encloses the smaller circle. The smaller circle is also light gray and has a small solid gray dot at its center. The circles are positioned to the left of the chapter title.

## **4 Developing and Installing Applications**

Use this chapter to understand the guidelines for developing applications and converting existing Trakker Antares applications for use on the CV60. You will also find information on installing applications and automatically launching them. This chapter contains these sections:

- Developing Applications for the CV60
- Installing Applications on the CV60

## Developing Applications for the CV60

The CV60 Vehicle Mount Computer can run applications that are programmed in:

- Microsoft eMbedded Visual C++ version 4.0 with SP2 for native C++ development for CV60s.

Use this section to understand the hardware and software you need to:

- develop a new application for the CV60.
- develop a web-based application for the CV60.
- convert a Trakker Antares application to a CV60 application.

### Developing a New Application

Use the Intermec resource kits to develop new applications to run on the CV60. The Intermec Resource kits are a library of C++ and .NET components grouped by functionality that you can use to create applications for the CV60. The resource kits are part of the Intermec Developers Library (IDL), and can be downloaded from the Intermec web site at [www.intermec.com/idl](http://www.intermec.com/idl).

You need these hardware and software components to use the Intermec resource kits:

- Pentium PC, 400 MHz or higher
- Windows 2000 (SP2 or later) or Windows XP (Home, Professional, or Server)
- 128 MB RAM (196 MB recommended)
- 360 MB hard drive space for minimum installation (720 MB for complete)
- CD-ROM drive compatible with multimedia PC specification
- VGA or higher-resolution monitor (Super VGA recommended)
- Microsoft mouse or compatible pointing device

## Developing a Web-Based Application

You can develop web-based data collection applications for use on the CV60. For help, see any HTML source book. The CV60 contains Internet Explorer for you to use. Microsoft Internet Explorer is available from the Start menu and provides all of the common elements you expect to find.

## Converting a Trakker Antares Application for the CV60

If you have an existing Trakker Antares application that you would like to run on the CV60, you can use the Antares Migration Resource Kit to convert it. The Antares Migration Resource Kit is a set of libraries and tools that you use to convert your existing Trakker Antares C applications into C++ applications for use on the CV60.

You need these hardware and software components to use the resource kit:

- PC with at least 1 MB of free disk space running Microsoft Windows 2000/XP
- Microsoft Visual Studio 2005
- Antares Migration Resource Kit

The resource kit is part of the Intermec Developer's Library (IDL), which you can download from the Intermec web site at [www.intermec.com/idl](http://www.intermec.com/idl).

## Installing Applications on the CV60

There are several ways you can install applications on the CV60:

- You can package your application as a cabinet (.cab) file.
- If you have a simple application, you may only need to deliver the .exe file.
- You can copy a director structure that contains the application, supporting files, DLLs, images, and data files.

There are several ways you can install files and applications on the CV60.

- SmartSystems server
- WaveLink Avalanche



- ActiveSync

### Installing Applications Using SmartSystems Server

You can use the SmartSystems server to drag-and-drop Intermec applications onto your CV60s. The CV60 ships with the SmartSystems client, which means it is SmartSystems-enabled. The console is part of SmartSystems Foundation, which you can download from [www.intermec.com/SmartSystems](http://www.intermec.com/SmartSystems). For help using the console, see the online help.

#### To use SmartSystems Console to install an application

- 1 Download your application file from the Intermec web site and unzip it on your desktop PC.
- 2 Double-click the application file to install it. The application file should appear in the software vault.
- 3 From the SmartSystems console in the Software Vault, drag-and-drop the application onto each CV60 in your network.

### Installing Applications Using Microsoft ActiveSync

You can use Microsoft ActiveSync to establish a connection between your PC and the CV60.

ActiveSync transfers files, synchronizes files, performs remote debugging, and other device management activities. For more information on installing and using ActiveSync, see [“Using Microsoft ActiveSync” on page 19](#).

You can have a USB or 802.11 ActiveSync connection to the CV60. When you only have a few CV60s to update, you can copy files using Windows Explorer on a PC.

This procedure assumes that Microsoft ActiveSync is installed on your PC and is up and running.

#### To install an application on the CV60 using ActiveSync

- 1 Connect the CV60 to a PC using a serial cable (P/N 321-563-003).
- 2 Wait for a “Connected” message to appear in the Microsoft ActiveSync application to signal a connection to the CV60.  
If necessary, select **File > Get Connected** to initiate a connection.

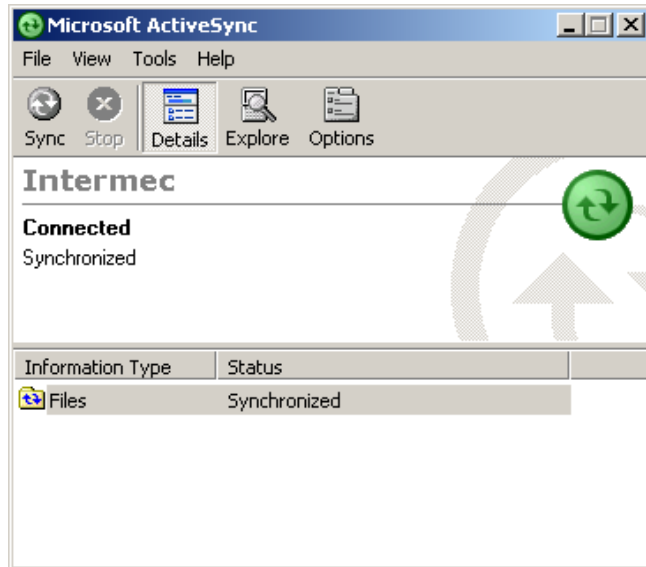

- 3 Click **Explore** to open the Mobile Device window on the CV60.
- 4 On your desktop PC, locate the executable file you want to download to the CV60 and copy it.
- 5 From the Mobile Device window, navigate to the folder where you want to paste the file.
- 6 Paste the executable file into the desired folder.
- 7 When you are done copying executable files, reset the CV60.
- 8 After the CV60 is done resetting, tap **Start > Programs > Windows Explorer** to locate the newly copied files.
- 9 Tap the file to install them.

## Installing Applications Using Wavelink Avalanche

You can use the Wavelink Avalanche device management system to install applications on all of your wireless CV60s. The CV60 ships with the Avalanche Enabler already loaded on it.

Each time the Avalanche Enabler is activated (typically on a reset), the CV60 attempts to connect to the Avalanche Agent. When the CV60 connects to the agent, the agent determines whether an update is available and immediately starts the software upgrade, file transfer, or configuration update.

### **To use Avalanche to remotely manage the CV60**

- 1** Install software packages and updates for the CV60 using the Avalanche Administrative Console.
- 2** Schedule the CV60 updates or manually initiate an update using the Avalanche Administrative Console.

For more information on using Wavelink Avalanche, contact your local Intermec representative or visit the Wavelink web site at [www.wavelink.com](http://www.wavelink.com).



## **5 Upgrading, Troubleshooting, and Cleaning the CV60**

If you encounter any problems while using the CV60, look in this chapter to find the possible solution. You will also find information on routine maintenance. This chapter contains these sections:

- Upgrading the CV60
- Troubleshooting the CV60
- Calling Product Support
- Cleaning the CV60 Screen

## Upgrading the CV60

The CV60 is highly configurable and allows you to upgrade these devices:

- Hard Drives
- Memory

### Increasing Hard Drive Space

You can upgrade your hard drive to increase file storage and software installation. The hard drive is located on the back of the CV60 under the rear cover. You must remove the rear cover to access the hard drive bay.



**Note:** In order to preserve the performance of the CV60 and be RoHS compliant, you should only use Intermec recommended hard drives.

#### To install a new hard drive

- 1 Turn off the CV60 by tapping **Start > Shutdown**.
- 2 Using a small Phillips screwdriver, remove the ten screws securing the back cover.

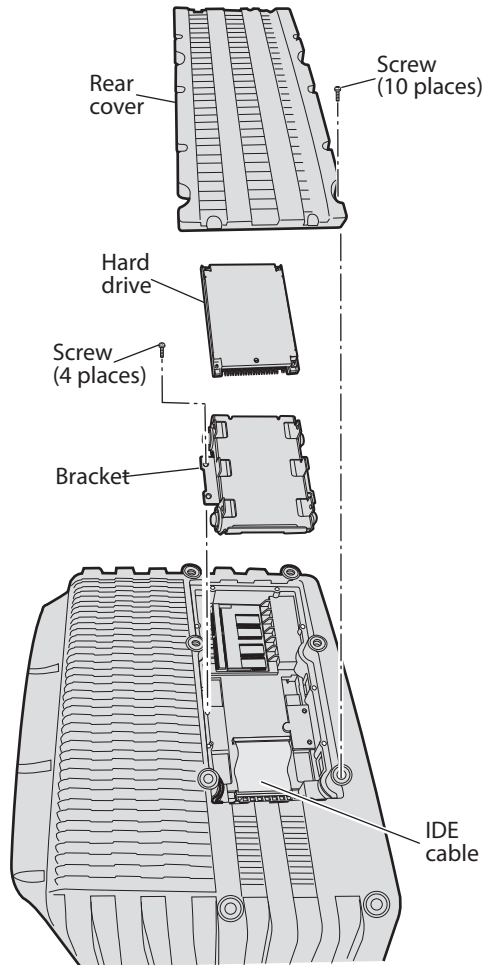

- 3** Remove the IDE cable cover by unscrewing the two screws that secure it.
- 4** Disconnect the IDE cable from the CV60.
- 5** Unscrew the four screws that secure the hard drive and the hard drive bracket and disconnect the IDE cable from the hard drive.
- 6** On the new hard drive, set the jumper settings to “Master”. Refer to the *CV60 Hard Drive Replacement Guide* (P/N 962-054-006A) for more information.

- 7 Attach the IDE cable to the hard drive and secure the hard drive to the hard drive bracket with the four screws that were removed in Step 5.
- 8 Attach the IDE cable to the CV60 and attach the cable cover that you removed in Step 4.
- 9 Close the CV60.

## **Increasing Memory**

The CV60 comes with 256 MB of SDRAM which is expandable to 512 MB.

### **To install memory into the CV60**

- 1 Using a Phillips screwdriver, remove the ten screws that secure the rear cover to the CV60. This will expose the memory slot.

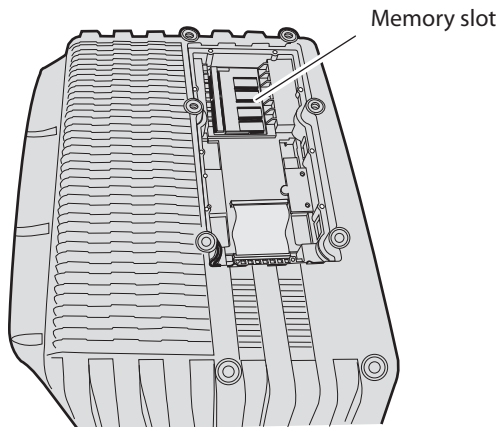

- 2 Take your new memory module and insert it into the memory slot.
- 3 Push down on the memory module until the two metal contacts clamp onto the memory module.
- 4 Attach the rear cover with the ten screws that you had removed in Step 1.



**Note:** The SODIMM slot (Single Outline Dual Inline Memory Module) allows upgrading the base memory from 256 MB to 512 MB with an Intermec approved SDRAM card.

## Troubleshooting the CV60

If you send the CV60 in for service, it is your responsibility to save the computer data and configuration. Intermec is responsible only for ensuring that the hardware matches the original configuration when repairing or replacing the computer.

If any problems with the TE2000 terminal emulation applications, see the *TE 2000 Terminal Emulation Programmer's Guide* (P/N 977-055-xxx).

### Problems While Operating the CV60

Problem	Solution
You press Power and nothing happens.	Make sure you are connected to a power supply.
The computer appears to be locked up and you cannot enter data.	Try these possible solutions in order: <ul style="list-style-type: none"><li>• If you have a CV60 with an 802.11 radio, wait 10 seconds and try to use the CV60 again. If the CV60 is still connecting to the Intermec Application Server or the host, it ignores any input from the keypad or scanner.</li><li>• Press the <b>Power</b> button to turn off the CV60 and then turn it back on.</li><li>• If the CV60 will not boot or reset, contact your local Intermec representative for help.</li></ul>



**Problems While Configuring Security**

<b>Problem</b>	<b>Solution</b>
The CV60 indicates that it is not authenticated.	Make sure that: <ul style="list-style-type: none"><li>• the CV60 IP address, host IP address, subnet mask, and default router are properly configured for your network.</li><li>• the Username and Password parameters on the CV60 match the username and password on the authentication server. You may need to re-enter the password on both the CV60 and the authentication server.</li><li>• on your authentication server, the user and group are allowed and the group policy is allowed to log in to the server. For help, see the documentation that shipped with your authentication server software.</li><li>• the IP address and secret key for your access point must match the IP address and secret key on your authentication server. You may need to re-enter the IP address and secret key on both your access point and authentication server.</li><li>• your authentication server is active and that it can communicate with your access point.</li></ul>
The CV60 indicates that it is authenticated, but does not communicate with the host.	Make sure that the CV60 IP address, host IP address, subnet mask, and default router are properly configured for your network.
You are setting up multiple access points in a network, with different SSIDs, and the connection fails.	The CV60 does not save WEP key values when you change the SSID. Reenter the WEP key value after you change the SSID and save your changes. You should now be able to connect to the different access points.
You are using static WEP keys and you have a strong connection to the access point, but you cannot communicate with it.	Make sure you are using the correct static WEP key. Sometimes you can see the strong signal strength and that security is enabled even with the WEP key set incorrectly.

**Problems With Wireless Connectivity**

Problem	Solution
<p>The network connection icon is in the taskbar, but the host computer is not receiving any data from the CV60.</p>	<p>In a UDP Plus network, there may be a problem with the connection between the Intermec Application Server and the host computer. Check with your network administrator or see the user’s manual for the Intermec Application Server.</p> <p>In a TCP/IP network, there may be a problem with the access point and the host computer. Check with your network administrator or use your access point user’s manual.</p>
<p>The CV60 is connected to the Intermec Application Server or host computer and you move to a new site to collect data. You do not appear to be connected to the network.</p>	<p>You may have gone out of range of an access point. Try moving closer to an access point or to a different location to reestablish communications. Once you are in range again, the network connection icon appears again. Any data you collected while out of range is transmitted over the network.</p>
<p>The CV60 is not communicating with the access point.</p>	<p>Try these possible solutions in order:</p> <ul style="list-style-type: none"> <li>• The CV60 is not connected to the access point. Make sure the access point is turned on and operating. You may also be using the CV60 out of range of an access point. Try moving closer to an access point to reestablish communications.</li> <li>• There may be a problem with the host computer, a problem with the connection between the Intermec Application Server and the host computer, or a problem with the connection between the access point and the host computer. Check with your network administrator to make sure the host is running and allowing users to login to the system.</li> <li>• Make sure the CV60 is configured correctly for your network. The radio parameters on the CV60 must match the values set for all access points the CV60 may communicate with. For help, see <a href="#">“Setting Up 802.11 Radio Communications” on page 30</a>.</li> <li>• The radio initialization process may have failed on the 802.11 radio. Reset the CV60.</li> </ul> <p>If you have tried these possible solutions and nothing happens, you may have a defective radio card. For help, contact your local Intermec service representative.</p>

### Problems While Scanning Bar Codes

Problem	Solution
You cannot see a red beam of light from the connected scanner when you press the <b>Scan</b> button and aim the scanner at a bar code label.	There are three possible problems: <ul style="list-style-type: none"><li>• You have not enabled the scanner. Check to see if your scanner is enabled through Intermec Settings. For help, see <a href="#">“Connecting a Tethered Scanner” on page 11</a> or <a href="#">“Configuring the CV60 to Communicate With a Wireless Scanner” on page 26</a>.</li><li>• You may be too far away from the bar code label. Try moving closer to the bar code label and scan it again.</li><li>• You may be scanning the bar code label “straight on.” Change the scanning angle and try again. You can test the effective range of the scanner. Move within 61 cm (2 ft) of a wall and test the scanner. You need to be within the scanning range to scan bar code labels.</li></ul>
The input device attached to the computer does not appear to work well or read bar code labels very quickly.	There are two possible problems: <ul style="list-style-type: none"><li>• Try setting the Scanner Model command to the specific input device you have attached.</li><li>• Check the bar code symbologies you have enabled on the CV60. Enable only the symbologies being used.</li></ul>
You scan or enter an option for the Scanner Model configuration command and you hear three low beeps.	If you are working in Intermec Settings, you cannot scan configuration commands. Exit Intermec settings to scan configuration commands.
You scan or enter an option for the Scanner Model configuration command and you hear three low beeps.	You may have scanned or entered a Scanner Model command that does not apply to the type of scanner that you have installed. Try scanning or entering the Scanner Model command again and select an option for the type of device you are using.

**Problems While Scanning Bar Codes (continued)**

Problem	Solution
<p>You scan a valid bar code label to enter data for your application. The data decoded by the scan module does not match the data encoded in the bar code label.</p>	<p>The computer may have decoded the bar code label in a symbology other than the label's actual symbology. Try scanning the bar code label again. Make sure you scan the entire label. To operate the computer quickly and efficiently, you should enable only the bar code symbologies that you are going to scan.</p>
<p>The scanner does not read the bar code labels quickly, or scanning beam seems to be faint or obscured.</p>	<p>The scanner window may be dirty. Clean the window with a solution of ammonia and water. Wipe dry. Do not allow abrasive material to touch the window.</p>
<p>The scanner will not read the bar code label.</p>	<p>Try these possible solutions in order:</p> <ul style="list-style-type: none"> <li>• Make sure you aim the scanner beam so it crosses the entire bar code label in one pass.</li> <li>• The angle you are scanning the bar code label may not be working well, or you may be scanning the label "straight on." Try scanning the bar code label again, but vary the scanning angle.</li> <li>• The bar code label print quality may be poor or unreadable. To check the quality of the bar code label, try scanning a bar code label that you know will scan. Compare the two bar code labels to see if the bar code quality is too low. You may need to replace the label that you cannot scan.</li> </ul> <p>Make sure that the application you are running on the computer is expecting input from a bar code. You may need to type this information instead of scanning it.</p>
<p>You selected 1551E or 1553 and enabled the scanner port, but the scanner does not scan.</p>	<p>Try these possible solutions in order:</p> <ul style="list-style-type: none"> <li>• Select ASCII as the scanner model.</li> <li>• Make sure that you are using the correct cable and that it is attached correctly (when you attach the scanner to the port, it should emit a single power up beep).</li> <li>• Try enabling the port state using Intermec Settings.</li> <li>• Try upgrading the scanner firmware.</li> </ul>

**Problems While Scanning Bar Codes (continued)**

<b>Problem</b>	<b>Solution</b>
Your 1551E or 1553 scanner was working fine, but after changing the port setting you cannot change the configuration.	The 1551E or 1553 scanner must be using the correct RS-232 settings to allow configuration in the Intermecc Settings applet. Try disabling, then enabling the scanner port state.
The configuration settings in Intermecc Settings do not match the settings on your 1551E or 1553 scanner.	Try disabling and then enabling the scanner port state to synchronize the CV60 settings with the scanner.

## **Calling Product Support**

If you cannot find the answer to your problem in the “Troubleshooting the CV60” section, you can visit the Intermecc technical knowledge base (Knowledge Central) at [intermec.custhelp.com](http://intermec.custhelp.com) to review technical information or to request technical support. If you still need help after visiting Knowledge Central, you may need to call Product Support.

To talk to an Intermecc Product Support representative, call:

**1-800-755-5505**

Before you call Intermecc Product Support, make sure you have the following information ready:

- Operating system version
- Configuration number
- If you are using security, know the type (Funk or Microsoft) and the full set of parameters
- Power management settings
- If you are using terminal emulation (TE), know the version and protocol
- If you are not using TE, know the language your custom application was written in and the tools you used to create it

You can find most of the information listed above in Intermecc Settings. Consult your application developer for information on your custom application.

**To find your operating system**

- **Start > Programs > Internet Explorer**

An Intermecc page opens and displays the OS version loaded on the CV60.

**To find your configuration number**

- Look at the label on the bottom of the CV60.

## **Cleaning the CV60 Screen**

To keep the CV60 in good working order, you may need to clean the screen whenever necessary depending on the environment in which you use the computer. To clean the CV60, use a solution of ammonia and water.

**To clean the screen**

- 1** Turn off the CV60 by tapping **Start > Shutdown**.
- 2** Dip a clean towel or rag in the ammonia solution and wring out the excess.

Wipe off the screen. Do not allow any abrasive material to touch these surfaces. Wipe dry.



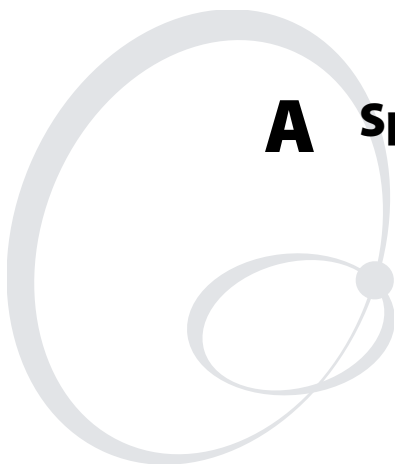

## **A Specifications**

Use this section to locate technical information about the CV60 and its available options and accessories.



## Specifications

### Physical Dimensions

Height:	27.1 cm (10.6 in)
Width:	34 cm (13.4 in)
Depth:	9.5 cm 3.7 in)
Weight:	5 kg (11 lbs)

### Hardware

Memory:	256MB SDRAM expandable to 512MB; 512KB Flash
Processor:	Intel P-III Ultra Low Power 800 MHz embedded processor
Hard drive:	1, 2, and 40GB hard drive options
Display:	12.1 inch color SVGA 800 x 600 TFT LCD unit with replaceable touch panel

### Power Specifications

Operating:	12-72 VDC input DC/DC 15-96 VDC input DC/DC AC/DC converter
Electrical rating:	⎓ 12V, 4A

### Temperature and Humidity Specifications

Operating temperature:	-20° to 50°C (-4° to 122°F)
Extreme operating temperature:	-30° to 50°C (-22° to 122°F) - Solid state HDD (with heated display option)
Storage temperature:	0° to 50°C (32° to 122°F)
Humidity:	5 to 95% RH non-condensing

## Accessories for the CV60

You can use these accessories (sold and ordered separately) with the CV60. To order accessories, contact your local Intermec sales representative.

### **AC Power Supply (P/N 203-787-001)**

Use this power supply to supply AC power to the CV60. The AC power supply comes with a North American power cord. You need to purchase a country-specific power cord for your local power source.

### **DC/DC (12-72 VDC) Power Supply (P/N 203-779-00x)**

Use this power supply kit with 12-72 V powered vehicles.

### **DC/DC (15-96 VDC) Power Supply (P/N 203-780-00x)**

Use this power supply kit with 15-96 V powered trucks.

### **Desktop Mounting Kit (P/N 203-785-001)**

Use this desktop mounting kit to attach the CV60 to a flat surface such as a desktop.

### **Keyboard (P/N 850-551-00x)**

You can purchase this alphanumeric keyboard to use with your CV60.

### **Keyboard Tray Mount (P/N G9A-KB000-01)**

Use this mounting kit to attach the keyboard to the CV60.

### **Scanner Cables**

Use the appropriate scanner cables to connect scanning devices such as the 1553 laser scanner. For more information, contact your local Intermec representative.

### **Vehicle Mounting Kit (P/N 203-784-001)**

Use the vehicle mounting kit to attach the CV60 to a vehicle such as a forklift or truck. This kit does not include a power supply, which can be purchased separately. For more information, contact your local Intermec representative.





## **| Index**

## Index

### Numerics

802.11

- configuring bands, 30
- overview, 30

802.1x

- configuring security with Funk security, 39

802.1x security

- overview, 34

### A

AC power supply

- description, 79
- illustration, 8

accessing programs

- with Windows CE, 17

accessories

- AC power supply, 79
- DC/DC power supply, 79
- desktop mounting kit, 79
- keyboard, 79
- keyboard tray mount, 79
- scanner cables, 79

Active Directory, using to issue certificates, 55

ActiveSync

- installing applications, 62
- overview, 19
- using, 19

ad-hoc network, defined, 32

adjusting

- beeper settings, 6
- brightness, 6
- volume settings, 6

Advanced Encryption Standard (AES), 33

AES data encryption, 33

antenna, installing, 10

applications

- converting Trakker Antares, 61
- developing, 60
  - new applications, 60
  - web-based, 61
- developing web-based, 61
- installing, 61

- using Microsoft ActiveSync, 62
- using SmartSystems Server, 62
- using Wavelink Avalanche, 63

overview, 60

association label, configuring wireless scanner, 26

attaching power, 8

authentication

server, defined, 33

Avalanche (Wavelink)

installing applications, 63

### B

bar code scanning

troubleshooting, 72

beeper settings, adjusting, 6

blue light description, 9

Bluetooth

class of device setting, defined, 25

configuring wireless scanner

using association label, 26

using Bluetooth Wizard for Windows CE, 26

connectable setting, defined, 25

device address setting, defined, 25

discoverable setting, defined, 25

IBT setting, defined, 25

power setting defined, 25

radio setting, defined, 25

setting up, 24

turning radio on, 25

bluetooth, 25

wireless printing

configuring for Windows CE, 28

bottom view illustration, 3

brightness, adjusting, 6

button descriptions, 3

### C

certificates

for security, described, 54

issued by

Active Directory, 55

third-party certificate authority, 55

loading

methods, described, 54

multiple certificates, 56

class of device, setting for Bluetooth, 25

COM port descriptions, 3

configuration number, location, 75

- configuring
  - Bluetooth
    - wireless scanners, 26
  - EAP-FAST security, 50
  - Ethernet communications, 23
  - Funk security with Profile Wizard, 41
  - LEAP security, 40, 48
  - Microsoft security, 51
  - operating parameters, 22
  - parameters
    - using Intermec Settings, 22
    - using SmartSystems Foundation, 23
  - PEAP security, 44
  - security, 32
  - serial communications, 23
  - TCP/IP network parameters, 30
  - TLS security, 45
  - TTLS security, 47
  - UDP Plus network parameters, 31
  - WEP security
    - with Funk security, 41
    - with Microsoft security, 54
    - with Profile Wizard, 42
  - wireless communications, 30
  - wireless scanner using association label, 26
  - WPA security with Microsoft security, 54
  - WPA2-PSK security
    - with Funk security, 38
    - with Profile Wizard, 44
  - WPA-PSK security
    - with Profile Wizard, 43
- configuring WPA Security With Funk Security, 36
- connectable setting for Bluetooth, 25
- connecting
  - antenna, 10
  - keyboard, 11
  - power, 7
- Control Panel
  - adjusting
    - beeper, 6
    - brightness, 6
    - volume, 6
- CV60 Vehicle Mount Computer
  - blue light, 9
  - good read light, 9
  - illustrations
    - attaching power, 8
    - bottom view, 3
    - front view, 2
    - status lights, 8
  - introducing, 2
  - port descriptions, 3
    - COM ports, 3
    - Ethernet port, 4
    - headphone jack, 3
    - keyboard port, 3
    - microphone jack, 3
    - power connector, 4
    - USB ports, 3
  - power button description, 4
  - Ready-to-Work indicator, 9
  - specifications, 78
- D**
  - DC/DC power supply, description, 79
  - description, LED lights, 9
  - desktop mounting kit, description, 79
  - developing applications, 60
  - device address setting for Bluetooth, 25
  - disabling security, 57
  - discoverable setting for Bluetooth, 25
  - display
    - cleaning, 75
    - overview, 4–6
    - using, 5
- E**
  - EAP, defined, 33
  - EAP-FAST security, configuring, 50
  - electrical rating, 78
  - enabling Bluetooth radio, 25
  - Enterprise mode, defined, 33
  - Ethernet communications, setting up, 23
  - Ethernet port description, 4
  - Extensible Authentication Protocol (EAP), defined, 33
  - external antenna, installing, 10
  - external keyboard, installing, 11
- F**
  - features, CV60, 2
  - finding, configuration number, 75

## Index

- front view illustration, 2
- Funk security
  - configuring
    - using Profile Wizard, 41
    - WPA2-802.1x, 36
    - WPA2-PSK, 38
    - WPA-802.1x, 36
    - WPA-PSK, 38
  - deciding to choose, 35
  - selecting a profile, 36
- G**
- good read light description, 9
- green light description, 9
- H**
- hard drive, installing, 66
- hardware specifications, 78
- headphone jack description, 3
- humidity specifications, 78
- I**
- IBT setting for Bluetooth, 25
- illustrations
  - attaching power, 8
  - bottom view, 3
  - front view, 2
  - status lights, 8
- infrastructure network, defined, 32
- installing
  - a hard drive, 66
  - applications using Microsoft ActiveSync, 62
  - applications using SmartSystems Server, 62
  - applications using Wavelink Avalanche, 63
  - applications, overview, 61
  - external antenna, 10
  - external keyboard, 11
  - memory, 68
  - tethered scanner, 11
- Intermec Computer Command Reference Manual, 22
- Intermec Settings
  - adjusting
    - beeper, 6
    - brightness, 6
    - volume, 6
  - configuring parameters, 22
  - finding list of all commands, 22
- Internet Explorer
  - overview, 20
  - using, 20
- K**
- keyboard port description, 3
- keyboard tray mount, description, 79
- keyboard, description, 79
- keyboard, installing, 11
- L**
- LCD
  - overview, 4–6
  - using, 5
- LEAP security
  - configuring, 40, 48
  - overview, 34
- LED lights
  - description, 9
  - overview, 8
- loading a certificate for security, 54
- loading applications
  - overview, 61
  - using Microsoft ActiveSync, 62
  - using SmartSystems Server, 62
  - using Wavelink Avalanche, 63
- location, configuration number, 75
- M**
- memory, installing, 68
- microphone jack description, 3
- Microsoft ActiveSync
  - installing applications, 62
  - overview, 19
  - using, 19
- Microsoft Internet Explorer
  - overview, 20
- Microsoft security
  - configuring WEP, 54
  - configuring WPA, 54
  - deciding to choose, 35
  - overview, 51
  - selecting as security choice, 51
- Microsoft Windows CE
  - accessing programs, 17

- configuring for wireless printing, 28
  - overview, 16
  - understanding, 16
  - using Internet Explorer, 20
  - using the input panel, 18
  - wireless scanner
    - configuring using Bluetooth Wizard, 26
- monitor
  - overview, 4–6
  - using, 5
- N**
- network protocols supported, 31
- new applications, developing, 60
- O**
- operating parameters, configuring, 22
- operating power specifications, 78
- operating the CV60, troubleshooting, 69
- P**
- parameters
  - configuring using Intermec Settings, 22
  - configuring using SmartSystems Foundation, 23
- parameters, configuring operating, 22
- passphrase
  - setting for Funk WPA-PSK, 38
- PEAP security
  - configuring with the Profile Wizard, 44
  - overview, 34
- physical dimensions, specifications, 78
- port descriptions, 3
  - COM ports, 3
  - Ethernet port, 4
  - headphone jack, 3
  - keyboard port, 3
  - microphone jack, 3
  - power button, 4
  - power connector, 4
  - USB ports, 3
- power
  - attaching, 7
  - button description, 4
  - connector description, 4
  - setting for Bluetooth, 25
  - specifications, 78
- Pre-Shared Key mode, defined, 33
- problems
  - bar code scanning, 72
  - configuring security, 70
  - operating the CV60, 69
  - wireless connectivity, 71
- product support
  - contacting, 74
- profile
  - selecting for Funk security, 36
  - selecting for Funk with Profile Wizard, 41
- Profile Wizard
  - using to configure EAP-FAST security, 50
  - using to configure Funk security, 41
  - using to configure LEAP security, 48
  - using to configure PEAP security, 44
  - using to configure TLS, 45
  - using to configure TTLS, 47
  - using to configure WEP security, 42
  - using to configure WPA2-PSK security, 44
  - using to configure WPA-PSK security, 43
- PSK mode, defined, 33
- R**
- radio
  - setting for Bluetooth, 25
  - turning Bluetooth on, 25
- radio communications, 802.11
  - configuring bands, 30
  - overview, 30
- Ready-to-Work light
  - description, 9
  - states, 10
- remotely configuring using SmartSystems Foundation, 23
- S**
- scanner
  - tethered, installing, 11
  - wireless
    - using association label, 26
    - wireless, configuring, 26
- scanner cables, description, 79



## Index

- scanner, installing, 11
  - screen
    - cleaning
      - LCD display, cleaning, 75
  - security
    - 802.1x overview, 34
    - choice, Funk or Microsoft, defined, 35
    - configuring
      - 802.1x with Funk security, 39
      - EAP-FAST security, 50
      - LEAP, 40
      - LEAP security, 48
      - Microsoft, 51
      - PEAP security, 44
      - TLS security, 45
      - TTLS security, 47
      - WEP security
        - with Funk security, 41
        - with Microsoft, 54
      - WPA security with Microsoft, 54
      - WPA2-802.1x security, with Funk security, 36
      - WPA2-PSK security
        - with Profile Wizard, 44
      - WPA-802.1x security with Funk security, 36
      - WPA-PSK security
        - with Profile Wizard, 43
    - disabling, 57
    - LEAP overview, 34
    - overview, 32
    - selecting Microsoft as security choice, 51
    - troubleshooting, 70
    - WEP overview, 35
    - WPA overview, 33
  - serial communications, setting up, 23
  - setting up
    - Bluetooth, 24
    - Ethernet communications, 23
    - serial communications, 23
  - settings, Bluetooth, 25
  - SmartSystems Foundation
    - configuring parameters, 23
  - SmartSystems Server, installing applications, 62
  - specifications
    - hardware, 78
    - humidity, 78
    - physical dimensions, 78
    - power, 78
    - temperature, 78
    - temperature and humidity, 78
  - SSID (Service Set Identifier), defined, 33
  - status lights
    - illustration, 8
    - overview, 8
  - supported network protocols, 31
- ## T
- TCP/IP
    - configuring network parameters, 30
  - temperature and humidity, specifications, 78
  - temperature specifications, 78
  - tethered scanner, installing, 11
  - third-party certificate authority, using to issue certificates, 55
  - TLS security
    - configuring, 45
    - overview, 34
  - touch screen
    - overview, 4–6
    - using, 5
  - Trakker Antares, converting applications, 61
  - troubleshooting, ??–66, 69–??
    - bar code scanning, 72
    - configuring security, 70
    - operating the CV60, 69
    - wireless connectivity, 71
  - TTLS security, configuring, 47
- ## U
- UDP Plus, configuring network parameter, 31
  - understanding the CV60, 2
  - understanding Windows CE, 16
  - upgrading
    - hard drive, 66
    - memory, 68
  - USB port descriptions, 3
  - using ActiveSync, 19

using the input panel with Windows CE, 18

## V

volume settings, adjusting, 6

## W

Wavelink Avalanche

installing applications, 63

web-based applications, developing, 61

WEP security

configuring

using Profile Wizard, 42

with Funk security, 41

with Microsoft security, 54

overview, 35

Windows CE, ??-19, ??-20

accessing programs, 17

configuring for wireless printing, 28

overview, 16

using ActiveSync, 19

using Internet Explorer, 20

using the input panel, 18

wireless scanner, configuring using Bluetooth Wizard, 26

wireless communications, configuring, 30

wireless connectivity

troubleshooting, 71

wireless printing

configuring in Windows CE, 28

wireless scanner

configuring

for Windows CE, 26

using association label, 26

configuring CV30 to communicate with, 26

wizard, profile

using to configure Funk security, 41

using to configure WEP security, 42

WPA security

configuring

with Microsoft security, 54

overview, 33

WPA2 security

overview, 33

WPA2-802.1x security

configuring with Funk security, 36

WPA2-PSK security

configuring with Funk security, 38

configuring with Profile Wizard, 44

## ***Index***

- WPA-802.1x security
  - configuring with Funk security, [36](#)
- WPA-PSK security
  - configuring with Funk security, [38](#)
  - configuring with Profile Wizard, [43](#)



**Worldwide Headquarters**  
6001 36th Avenue West  
Everett, Washington 98203  
U.S.A.

**tel** 425.348.2600

**fax** 425.355.9551

[www.intermec.com](http://www.intermec.com)

CV60 Vehicle Mount Computer User's Manual With Windows CE



P/N 934-004-005